

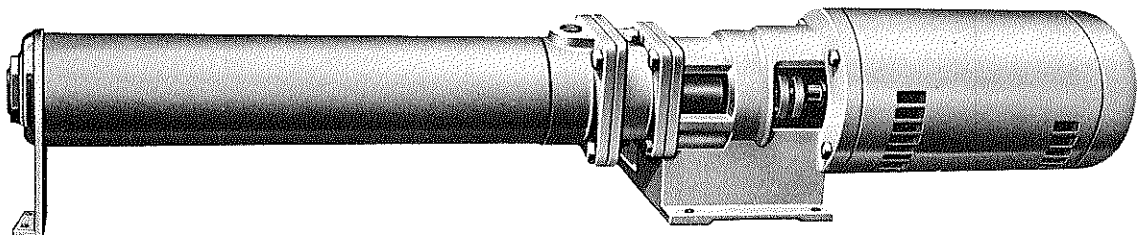

GOULDS PUMPS

Installation, Operation and Maintenance Instructions

MODEL 3935



IMPORTANT SAFETY NOTICE

To: Our Valued Customers

User safety is a major focus in the design of our products. Following the precautions outlined in this manual will minimize your risk of injury.

ITT Goulds pumps will provide safe, trouble-free service when properly installed, maintained, and operated.

Safe installation, operation, and maintenance of ITT Goulds Pumps equipment are an essential end user responsibility. This *Pump Safety Manual* identifies specific safety risks that must be considered at all times during product life. Understanding and adhering to these safety warnings is mandatory to ensure personnel, property, and/or the environment will not be harmed. Adherence to these warnings alone, however, is not sufficient — it is anticipated that the end user will also comply with industry and corporate safety standards. Identifying and eliminating unsafe installation, operating and maintenance practices is the responsibility of all individuals involved in the installation, operation, and maintenance of industrial equipment.

Please take the time to review and understand the safe installation, operation, and maintenance guidelines outlined in this Pump Safety Manual and the Instruction, Operation, and Maintenance (IOM) manual. Current manuals are available at www.gouldspumps.com/literature_ioms.html or by contacting your nearest Goulds Pumps sales representative.

These manuals must be read and understood before installation and start-up.

For additional information, contact your nearest Goulds Pumps sales representative or visit our Web site at www.gouldspumps.com.

SAFETY WARNINGS

Specific to pumping equipment, significant risks bear reinforcement above and beyond normal safety precautions.

 **WARNING**

A pump is a pressure vessel with rotating parts that can be hazardous. Any pressure vessel can explode, rupture, or discharge its contents if sufficiently over pressurized causing death, personal injury, property damage, and/or damage to the environment. All necessary measures must be taken to ensure over pressurization does not occur.

 **WARNING**

Operation of any pumping system with a blocked suction and discharge must be avoided in all cases. Operation, even for a brief period under these conditions, can cause superheating of enclosed pumpage and result in a violent explosion. All necessary measures must be taken by the end user to ensure this condition is avoided.

 **WARNING**

The pump may handle hazardous and/or toxic fluids. Care must be taken to identify the contents of the pump and eliminate the possibility of exposure, particularly if hazardous and/or toxic. Potential hazards include, but are not limited to, high temperature, flammable, acidic, caustic, explosive, and other risks.

 **WARNING**

Pumping equipment Instruction, Operation, and Maintenance manuals clearly identify accepted methods for disassembling pumping units. These methods must be adhered to. Specifically, applying heat to impellers and/or impeller retaining devices to aid in their removal is strictly forbidden. Trapped liquid can rapidly expand and result in a violent explosion and injury.

ITT Goulds Pumps will not accept responsibility for physical injury, damage, or delays caused by a failure to observe the instructions for installation, operation, and maintenance contained in this Pump Safety Manual or the current IOM available at www.gouldspumps.com/literature.

SAFETY

DEFINITIONS

Throughout this manual the words **WARNING**, **CAUTION**, **ELECTRICAL**, and **ATEX** are used to indicate where special operator attention is required.

Observe all Cautions and Warnings highlighted in this Pump Safety Manual and the IOM provided with your equipment.



WARNING

Indicates a hazardous situation which, if not avoided, could result in death or serious injury.

Example: Pump shall never be operated without coupling guard installed correctly.



CAUTION

Indicates a hazardous situation which, if not avoided, could result in minor or moderate injury.

Example: Throttling flow from the suction side may cause cavitation and pump damage.



ELECTRICAL HAZARD

Indicates the possibility of electrical risks if directions are not followed.

Example: Lock out driver power to prevent electric shock, accidental start-up, and physical injury.









When installed in potentially explosive atmospheres, the instructions that follow the Ex symbol must be followed. Personal injury and/or equipment damage may occur if these instructions are not followed. If there is any question regarding these requirements or if the equipment is to be modified, please contact an ITT Goulds Pumps representative before proceeding.













Example:  Improper impeller adjustment could cause contact between the rotating and stationary parts, resulting in a spark and heat generation.



GENERAL PRECAUTIONS

WARNING

A pump is a pressure vessel with rotating parts that can be hazardous. Hazardous fluids may be contained by the pump including high temperature, flammable, acidic, caustic, explosive, and other risks. Operators and maintenance personnel must realize this and follow safety measures. Personal injuries will result if procedures outlined in this manual are not followed. ITT Goulds Pumps will not accept responsibility for physical injury, damage or delays caused by a failure to observe the instructions in this manual and the IOM provided with your equipment.

| General Precautions | | |
|---------------------|---|--|
| WARNING | | NEVER APPLY HEAT TO REMOVE IMPELLER. It may explode due to trapped liquid. |
| WARNING | | NEVER use heat to disassemble pump due to risk of explosion from tapped liquid. |
| WARNING | | NEVER operate pump without coupling guard correctly installed. |
| WARNING |  | NEVER run pump below recommended minimum flow when dry, or without prime. |
| WARNING |  | ALWAYS lock out power to the driver before performing pump maintenance. |
| WARNING | | NEVER operate pump without safety devices installed. |
| WARNING |  | NEVER operate pump with discharge valve closed. |
| WARNING |  | NEVER operate pump with suction valve closed. |
| WARNING |  | DO NOT change service application without approval of an authorized ITT Goulds Pumps representative. |
| WARNING | | <p>Safety Apparel:</p> <ul style="list-style-type: none"> ♦ Insulated work gloves when handling hot bearings or using bearing heater ♦ Heavy work gloves when handling parts with sharp edges, especially impellers ♦ Safety glasses (with side shields) for eye protection ♦ Steel-toed shoes for foot protection when handling parts, heavy tools, etc. ♦ Other personal protective equipment to protect against hazardous/toxic fluids |
| WARNING | | <p>Receiving:</p> <p>Assembled pumping units and their components are heavy. Failure to properly lift and support equipment can result in serious physical injury and/or equipment damage. Lift equipment only at specifically identified lifting points or as instructed in the current IOM. Current manuals are available at www.gouldspumps.com/literature_ioms.html or from your local ITT Goulds Pumps sales representative. Note: Lifting devices (eyebolts, slings, spreaders, etc.) must be rated, selected, and used for the entire load being lifted.</p> |
| WARNING |  | <p>Alignment:</p> <p>Shaft alignment procedures must be followed to prevent catastrophic failure of drive components or unintended contact of rotating parts. Follow coupling manufacturer's coupling installation and operation procedures.</p> |

| General Precautions | | |
|----------------------------|---|---|
| WARNING |  | Before beginning any alignment procedure, make sure driver power is locked out. Failure to lock out driver power will result in serious physical injury. |
| CAUTION |  | Piping: Never draw piping into place by forcing at the flanged connections of the pump. This may impose dangerous strains on the unit and cause misalignment between pump and driver. Pipe strain will adversely effect the operation of the pump resulting in physical injury and damage to the equipment. |
| WARNING | | Flanged Connections: Use only fasteners of the proper size and material. |
| WARNING | | Replace all corroded fasteners. |
| WARNING | | Ensure all fasteners are properly tightened and there are no missing fasteners. |
| WARNING |  | Startup and Operation: When installing in a potentially explosive environment, please ensure that the motor is properly certified. |
| WARNING |  | Operating pump in reverse rotation may result in contact of metal parts, heat generation, and breach of containment. |
| WARNING |  | Lock out driver power to prevent accidental start-up and physical injury. |
| WARNING |  | The impeller clearance setting procedure must be followed. Improperly setting the clearance or not following any of the proper procedures can result in sparks, unexpected heat generation and equipment damage. |
| WARNING |  | If using a cartridge mechanical seal, the centering clips must be installed and set screws loosened prior to setting impeller clearance. Failure to do so could result in sparks, heat generation, and mechanical seal damage. |
| WARNING |  | The coupling used in an ATEX classified environment must be properly certified and must be constructed from a non-sparking material. |
| WARNING | | Never operate a pump without coupling guard properly installed. Personal injury will occur if pump is run without coupling guard. |
| WARNING |  | Make sure to properly lubricate the bearings. Failure to do so may result in excess heat generation, sparks, and / or premature failure. |
| CAUTION |  | The mechanical seal used in an ATEX classified environment must be properly certified. Prior to start up, ensure all points of potential leakage of process fluid to the work environment are closed. |
| CAUTION |  | Never operate the pump without liquid supplied to mechanical seal. Running a mechanical seal dry, even for a few seconds, can cause seal damage and must be avoided. Physical injury can occur if mechanical seal fails. |
| WARNING | | Never attempt to replace packing until the driver is properly locked out and the coupling spacer is removed. |
| WARNING |  | Dynamic seals are not allowed in an ATEX classified environment. |
| WARNING |  | DO NOT operate pump below minimum rated flows or with suction and/or discharge valve closed. These conditions may create an explosive hazard due to vaporization of pumpage and can quickly lead to pump failure and physical injury. |

| General Precautions | | |
|----------------------------|---|---|
| WARNING | | Ensure pump is isolated from system and pressure is relieved before disassembling pump, removing plugs, opening vent or drain valves, or disconnecting piping. |
| WARNING | | Shutdown, Disassembly, and Reassembly: Pump components can be heavy. Proper methods of lifting must be employed to avoid physical injury and/or equipment damage. Steel toed shoes must be worn at all times. |
| WARNING | | The pump may handle hazardous and/or toxic fluids. Observe proper decontamination procedures. Proper personal protective equipment should be worn. Precautions must be taken to prevent physical injury. Pumpage must be handled and disposed of in conformance with applicable environmental regulations. |
| WARNING | | Operator must be aware of pumpage and safety precautions to prevent physical injury. |
| WARNING |  | Lock out driver power to prevent accidental startup and physical injury. |
| CAUTION | | Allow all system and pump components to cool before handling them to prevent physical injury. |
| CAUTION |  | If pump is a Model NM3171, NM3196, 3198, 3298, V3298, SP3298, 4150, 4550, or 3107, there may be a risk of static electric discharge from plastic parts that are not properly grounded. If pumped fluid is non-conductive, pump should be drained and flushed with a conductive fluid under conditions that will not allow for a spark to be released to the atmosphere. |
| WARNING | | Never apply heat to remove an impeller. The use of heat may cause an explosion due to trapped fluid, resulting in severe physical injury and property damage. |
| CAUTION | | Wear heavy work gloves when handling impellers as sharp edges may cause physical injury. |
| CAUTION | | Wear insulated gloves when using a bearing heater. Bearings will get hot and can cause physical injury. |

ATEX CONSIDERATIONS and INTENDED USE

Special care must be taken in potentially explosive environments to ensure that the equipment is properly maintained. This includes but is not limited to:

1. Monitoring the pump frame and liquid end temperature.
2. Maintaining proper bearing lubrication.
3. Ensuring that the pump is operated in the intended hydraulic range.

The ATEX conformance is only applicable when the pump unit is operated within its intended use. Operating, installing or maintaining the pump unit in any way that is not covered in the Instruction, Operation, and Maintenance manual (IOM) can cause serious personal injury or damage to the equipment. This includes any modification to the equipment or use of parts not provided by ITT Goulds Pumps. If there is any question regarding the intended use of the equipment, please contact an ITT Goulds representative before proceeding. Current IOMs are available at www.gouldspumps.com/literature_ioms.html or from your local ITT Goulds Pumps Sales representative.

All pumping unit (pump, seal, coupling, motor and pump accessories) certified for use in an ATEX classified environment, are identified by an ATEX tag secured to the pump or the baseplate on which it is mounted. A typical tag would look like this:



The CE and the Ex designate the ATEX compliance. The code directly below these symbols reads as follows:

- II = Group 2
- 2 = Category 2
- G/D = Gas and Dust present
- T4 = Temperature class, can be T1 to T6 (see Table 1)

| Code | Max permissible surface temperature °F (°C) | Max permissible liquid temperature °F (°C) |
|-------------|--|---|
| T1 | 842 (450) | 700 (372) |
| T2 | 572 (300) | 530 (277) |
| T3 | 392 (200) | 350 (177) |
| T4 | 275 (135) | 235 (113) |
| T5 | 212 (100) | Option not available |
| T6 | 185 (85) | Option not available |

The code classification marked on the equipment must be in accordance with the specified area where the equipment will be installed. If it is not, do not operate the equipment and contact your ITT Goulds Pumps sales representative before proceeding.

PARTS



The use of genuine Goulds parts will provide the safest and most reliable operation of your pump. ITT Goulds Pumps ISO certification and quality control procedures ensure the parts are manufactured to the highest quality and safety levels.

Please contact your local Goulds representative for details on genuine Goulds parts.

TABLE OF CONTENTS

| SECTION I—GENERAL | PAGE |
|---|-------------|
| I-A. Importance of Instructions | 2 |
| I-B. Special Warnings | 3 |
| I-C. Receiving Inspection—Shortages | 3 |
| I-D. Preservation and Storage | 3 |
| I-E. Handling Techniques | 3 |
| SECTION II—INSTALLATION | |
| II-A. Location | 3 |
| II-B. Installation | 3 |
| II-C. Piping | 3 |
| II-D. Alignment Procedures | 4 |
| II-E. Mechanical Seals | 4 |
| SECTION III—OPERATION | |
| III-A. Start-up | 4 |
| III-B. Operational Checks | 5 |
| III-C. Shutdown Procedure | 5 |
| SECTION IV—PREVENTIVE AND CORRECTIVE MAINTENANCE | |
| IV-A. Lubrication | 6 |
| IV-B. Mechanical Seal | 6 |
| IV-C. Vibration | 6 |
| IV-D. Performance | 6 |
| SECTION V—DISASSEMBLY AND REASSEMBLY | |
| V-A. Disassembly of Pump | 6 |
| V-B. Inspection and Overhaul | 7 |
| V-C. Reassembly of Pump | 7 |
| V-D. Bearing and Seal Replacement | 9 |
| SECTION VI—ENGINEERING DATA | |
| VI-A. Sectional View | 10 |
| VI-B. Parts List and Materials of Construction | 11 |
| VI-C. Pressure/Temperature Capability | 11 |
| SECTION VII—TROUBLE SHOOTING | |
| VII-A. Trouble Shooting | 12 |
| SECTION VIII—ORDERING SPARE PARTS | |
| VIII-A. Ordering Spare Parts | 12 |
| VIII-B. Instructions for Ordering Spare Parts | 13 |

INTRODUCTION

This instruction manual is intended to assist those involved with the installation, operation, and maintenance of Goulds Model 3935 Multi-Stage Pumps.

It is recommended that this manual be thoroughly reviewed prior to installing or performing any work on the pump or motor.

SECTION I—GENERAL

A. IMPORTANCE OF INSTRUCTIONS

The design, material, and workmanship incorporated into the construction of Goulds pumps make

them capable of giving long, trouble-free service. The life and satisfactory service of any mechanical unit, however, are enhanced and extended by correct application, proper installation, periodic in-

spection, and careful maintenance. This instruction manual was prepared to assist operators in understanding the construction and correct methods of installing, operating, and maintaining these pumps.

Study thoroughly Sections I, II, III and carefully follow the instructions for installation and operation. Sections IV, V, VII, and VIII are answers to trouble and maintenance questions. Keep this instruction manual handy for reference. Further information can be obtained by contacting your local branch office or the Engineered Products Division, Goulds Pumps, Inc., Seneca Falls, New York 13148.

B. SPECIAL WARNINGS

Goulds Pumps, Inc. will not be liable for any damages or delay caused by failure to comply with the provisions of this instruction manual. This pump is not to be operated at speeds, working pressures, discharge pressures or temperatures higher than, nor used with liquids other than, stated in the original order acknowledgement without written permission of Goulds Pumps, Inc.

C. RECEIVING INSPECTION—SHORTAGES

Care should be taken when unloading pumps. If

shipment is not delivered in good order and in accordance with the Bill-of-Lading, note the damage or shortage on both receipt and freight bill. **MAKE ANY CLAIMS TO THE TRANSPORTATION COMPANY PROMPTLY.** Instruction sheets on various components, as well as the Instruction Book for the pump, are included in the shipment—**DO NOT DISCARD!**

D. PRESERVATION AND STORAGE

Goulds normal domestic storage preparation is suitable for protecting the pump during shipment in covered trucks. It also provides protection during covered storage at the jobsite, and for a short period between installation and start-up.

Caution—The Model 3935 is flushed with ethylene glycol at the factory and should be thoroughly flushed for 30 minutes prior to installation in the customer's system. A caution tag has been affixed to the pump regarding the instructions. Once the pump is flushed with water, it should be kept completely filled to minimize rust formation.

E. HANDLING TECHNIQUES

Care should be used in moving pumps. Where required by size of units, slings should be put under both pump and motor.

SECTION II—INSTALLATION

A. LOCATION

Pumping unit should be placed as close as practical to the source of supply. Floor space and head room allotted to the unit must be sufficient for inspection and maintenance. Be sure to allow for crane or hoist service.

B. INSTALLATION

Model 3935 pumps are multi-stage pumps, close-coupled to the driving motor. The pump should be supported only at the bearing frame (at the motor on pumps with Y frame) and pump foot. The unit should be bolted to a substantial, rigid base to prevent distortion of the pump.

Pumps should not be hoisted in the air for mounting purposes with the motor bolted to the frame. Motors should be mounted *after* the pump is securely installed on its permanent base.

Oh high temperature service, a gap should be left between the pump foot and end of the casing, or shoulder of the discharge head, to allow for thermal expansion. The pump foot bolt (371U) should not be tightened down until pump has reached operating temperature.

THE DISCHARGE HEAD SHOULD NEVER BE LOOSENED OR TIGHTENED TO MAKE UP PIPING DOWNSTREAM OF THE PUMP.

On pumps with flanged suction and discharge connections, the pump foot fits over the casing.

Oil lubricated pumps must be installed in the horizontal position. Grease lubricated pumps may be installed in the vertical position, but should have the motor above the pump. The Model 3935 should never run dry. If there is any possibility that the pump's source of liquid might fail, a protective device should be incorporated into the system to shut the pump down.

C. PIPING

The pump should not run with a closed discharge for more than a few minutes, such as during start-up or shut-down. Sufficient heat can be transmitted to the fluid causing the liquid to vaporize and allow the pump to run dry and fail. The suction pipe should never be of smaller diameter than the pump suction. Use of suction pipe one or two sizes larger than the pump suction, with a reducer at the pump suction, is desirable. **THE PUMP SHOULD NEVER BE THROTTLED ON THE SUCTION SIDE.** Quick closing valves should be avoided in the discharge line to protect the pump from damage due to surging and water hammer.

For operation at low flow, or to insure liquid will always be flowing through the pump, a bypass line should be installed. The bypass line should be re-

turned to the liquid source and injected below minimum liquid level to prevent air entrainment.

If a bypass line is not used, it is recommended that precautions be taken to insure that the pump will not run dry, run at closed discharge, or handle pumpage of excessive temperature at pump suction. Devices which can protect the pump from the above problems are flow switches or high temperature switches.

When handling liquids at elevated temperature, it is suggested that expansion loops or joints be installed in the suction and discharge so that expansion of the piping will not impose excessive strain on the pump.

Additional information on piping can be found in "Hydraulic Institute Standards."

D. ALIGNMENT PROCEDURES

Pumps which have NEMA C-flange motors directly mounted to the bearing frame do not require pump and motor shaft alignment. Jog motor to be sure rotation is correct before connecting coupling. Rotation is counter-clockwise when viewed from the coupling end.

E. MECHANICAL SEALS

The pump is equipped with a mechanical seal. Damage can result if mechanical seals are run dry or in abrasives. For special seals, follow the instructions on the seal drawing supplied with the order for recirculation, flush and/or cooling flows required.

SECTION III—OPERATION

A. START-UP

1. Check List

a. Lubrication

J Frame—J frame pumps have a greased-for-life ball bearing. No additional lubrication is required.

S Frame—S frame pumps have ball bearings which are greased at the factory.

Bearings should be regreased every 2000-3000 hours (3-4 months).

To regrease bearings:

- a. Remove plug on top of bearing frame. Screw in Alemite grease fitting included in the box fittings, shipped with the pump.
- b. Add grease while turning shaft by hand until old grease is forced out of grease relief fitting at bottom of bearing cap and fresh grease appears.
- c. Remove grease fitting and reinstall plug.

M, L, X, and Y Frames

M, L, X and Y frames have flood oil lubricated bearings. THE BEARINGS ARE NOT LUBRICATED AT THE FACTORY. A constant level oiler, #5 TRICO, is packed with the pump.

- a. Before installing the oiler on the bearing frame, check the oiler adjustment. The setting dimension .56" (14.3 mm) is illustrated in Figure 1.
- b. Remove the small plastic plug from the large pipe plug on the left side of frame as viewed from the motor end

of the pump. NOTE: The Y frame has a 1/4-18 NPT tapped hole.

- c. The nipple-elbow assembly is assembled finger-tight at the factory. Before installing it on pump, the threaded connections should be made up with pipe sealant.

NOTE: The oiler may be installed on the right side of the pump (viewed from motor end) by moving the 2"-11 1/2 NPT plug with 1/4"-18 NPT tapped hole to right side and assembling as above.

- d. Install the nipple-elbow assembly so that the long nipple [1/4 NPT x 1.75" (44mm) long] extends horizontally from the frame to the 90 degree elbow and the close nipple vertically from the elbow to the BOTTOM connection of the oiler. Refer to Figure 1.
 - e. Fill bearing reservoir using oiler bottle. Several fillings will be required. Never fill the frame through the frame breather located at the top of the frame or through the oiler without use of the bottle. This can result in overfilling and high oil temperature.
 - f. After starting pump, remove the breather. Oil viewed through the breather hole should be a mist. If oil is thrown out of the breather hole, or an oil mist is not visible, recheck all dimensions shown on Figure 1.
- b. Alignment
As described in Section II-D, alignment is normally built-in and need not be checked.

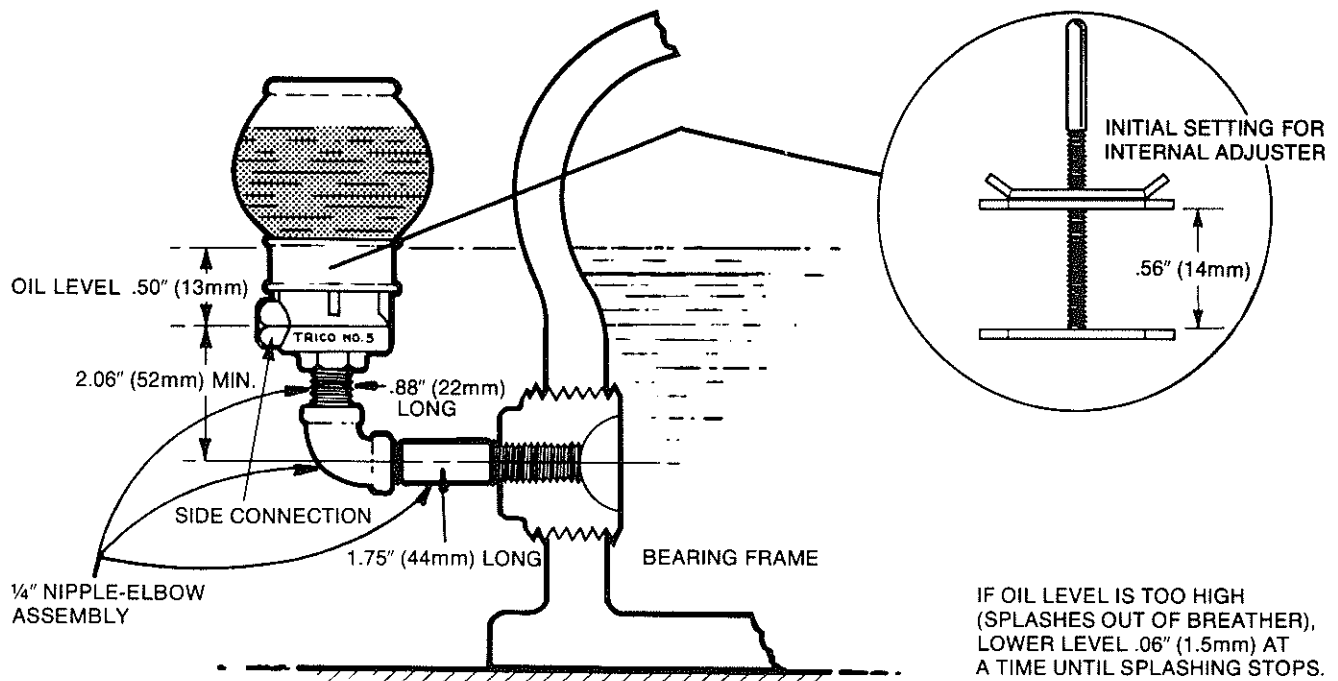

Figure 1

- c. Mechanical Seal
Refer to Section II-E. If auxiliary piping for cooling and/or flushing from an outside source is being used, establish these flows.
- d. Priming
Pump and suction pipe must be full of liquid before pump is started. Usually, suction supply will be primed when shut-off valves to pump are opened. If suction supply is below pump, priming by other means such as foot valve or ejector will be required.
- e. Check for Free Turning
Before pump is started, rotate shaft by hand to be sure it is free. If pump cannot be turned by hand, or binding and rubbing are noticed, correct before starting.

2. Start-up Procedures

- a. Valves
Be sure suction valve is fully open. Normally, discharge valve should be at least partially closed so that flow will be controlled.
- b. Rotation Check
With motor uncoupled from frame, jog motor to check for proper rotation. Rotation should be counter-clockwise when viewed from coupling end. Recouple when satisfied.
- c. Start
Pump is now ready to start.

B. OPERATIONAL CHECKS

Inspect pump carefully and frequently during the first few hours of operation. Mechanical seal may weep slightly but should "run in" in a few hours. Be sure all auxiliary lines (cooling, flushing, sealing, etc.) are functioning properly. Check pump bearings for excessive heating. Check motor for excessive heating. Check complete unit for excessive vibration or unusual noise. Do not run pump at greatly reduced flow because all the motor horsepower will go into heating the liquid in the pump and damage may result. **Do not run pump beyond maximum recommended flow since damage could result due to excessive wear on the back washers (546).**

| MAXIMUM RECOMMENDED FLOW | | | | |
|--------------------------|---------|------------------------|---------|------------------------|
| 60 Hertz Speed | | 50 Hertz Speed | | |
| BP20 | 25 GPM | 5.6 m ³ /h | 20 GPM | 4.5 m ³ /h |
| BP40 | 60 GPM | 13.6 m ³ /h | 50 GPM | 11.4 m ³ /h |
| BP70 | 100 GPM | 22 m ³ /h | 80 GPM | 18.2 m ³ /h |
| BP100 | 140 GPM | 32 m ³ /h | 115 GPM | 26 m ³ /h |
| BP200 | 220 GPM | 50 m ³ /h | 180 GPM | 40 m ³ /h |

C. SHUTDOWN PROCEDURE

If pump is installed with a check valve, it can be shut down without closing any valves. When no check valve is used, the discharge valve must be closed before the pump is stopped to prevent backflow through the pump. If the pump is to be serviced, be sure suction valves are closed, auxiliary cooling and flushing flows are shut off and motor is locked out before working on pump.

SECTION IV — PREVENTIVE AND CORRECTIVE MAINTENANCE

A. LUBRICATION

Refer to Section III-A for lubrication procedures for pump. Follow motor and coupling manufacturer's lubrication instructions.

B. MECHANICAL SEAL

The seal requires no attention other than to make sure that circulating lines, where installed, do not become clogged.

C. VIBRATION

It is good practice to periodically monitor vibration of the pump. Normally, vibration level will be well below accepted standards. Of equal importance is that the vibration level does not increase. If a problem with vibration is encountered, refer to Trouble Shooting, Section VII.

D. PERFORMANCE

If performance deteriorates, refer to Trouble Shooting, Section VII.

SECTION V — DISASSEMBLY AND REASSEMBLY

A. DISASSEMBLY OF PUMP

1. Lock out power source.
2. Shut off valves controlling flow to and from pump. Disconnect piping.
3. Drain pump through plug (408A) in bottom of casing adapter.

NOTE: If pump has handled corrosive liquids, the motor end should be elevated to assure complete draining. Flushing is recommended.

4. If pump is oil lubricated, drain oil through oil drain plug on bottom of bearing frame (228A).
5. Unbolt and remove motor from frame (228 or 228A).

NOTE: For pumps with other than insert-type couplings, see coupling manufacturer's instructions for removal.

6. Loosen set screw in coupling hub (233), and remove hub and key (400) from stub shaft (380).
7. Loosen bolt (371U) so that discharge head (152) can turn in pump foot (131). Do not remove pump foot at this time.
8. Slide a heavy bar or pipe through frame being careful not to let the bar contact the stub shaft (380). Place a wrench on the discharge head. Unscrew the discharge head until casing (100) is loose. Threads are right hand. Do not completely unscrew casing.
9. Set pump in a vertical position, resting on the frame (228 or 228A). Remove discharge head (152) and pump foot (131). Unscrew and remove casing (100) from casing adapter (108). The casing must be removed vertically so that the pump shaft is not bent. The total overhead clearance required will be the total pump length, less motor, plus the length of the casing (100).
10. Note location of casing O-rings (412K) and record.
11. Remove the shaft retaining ring (361) and shims (331) from shaft (122). Remove sleeves (157). Mark all parts for reassembly.

12. Slide diffusers (150), impellers (101), shims (331) and intermediate bearings (260) off shaft (122). Also, note that some pumps may have spacer blanks (150A) substituted for some of the stages. These will be located at the discharge end of the pump. Mark each impeller, diffuser, intermediate bearing and shim washer to identify its position with the pump to aid in reassembly.

13. Remove impeller key (178) from shaft.

14. Unbolt and remove casing adapter (108) from seal housing (159).

15. Remove pump shaft (122) from splined end of stub shaft. For pumps with special mechanical seal arrangements, the seal seat mount (158) is removed when the shaft is pulled out of the splined end of the stub shaft. This must be done carefully to avoid mechanical seal damage.

16. Remove seal from shaft only if it is to be replaced. Use care to avoid cutting rubber bellows on splined teeth of pump shaft. Remove retaining ring (361D) from shaft. NOTE: (BP20 does not use a retaining ring).

17. To remove the drive sleeve (522) and split collet (524) from the shaft, tap the drive sleeve (522) away from the splined end of the shaft (122) and off the split collet (524). A piece of pipe sized to seat against the larger end of the drive sleeve should be used for this. Spread the split collet with suitable tool, remove it from the groove in the shaft and slide it off the shaft.

18. Remove seal seat mount (158) if not already pulled. (228 or 228A).

19. Unbolt and remove seal housing (159) from bearing frame. (228 or 228A).

20. Unbolt and remove thrust bearing end cover (109 or 109A). On J frame thrust bearing, cover is not used. Remove retaining ring (361E).

21. Remove stub shaft assembly from bearing frame.

22. Remove thrust bearing locknut (136). (J frame does not have locknut).

23. Remove ball bearing (112 or 112A and 168A) using a suitable puller or press. Care must be taken to prevent damage to bearings. Do not use a hammer to drive shaft through bearings. Protect bearings from contamination.
24. Remove wave washer (259) from bearing frame. (J frame does not have wave washer).

B. INSPECTION AND OVERHAUL

1. **O-rings**—Inspect and replace if damaged.
2. **Shafts**—Check shafts for runout to be sure they are not bent. Bearing seats, retaining ring grooves, keyways, surfaces under oil seals, and surface under mechanical seal should be in good condition. Replace if faces are worn, scarred or cracked, or if elastomeric bellows is damaged.
4. **Thrust washer**—Inspect and replace if worn. The back thrust washer (546) is nominal .03" (0.8mm) thick, replace if worn to less than .02" (0.5mm).
5. **Intermediate and discharge head bearings**—Check for excessive wear in carbon bushings. Replace as necessary.
6. **Oil seal**—Replace if worn or damaged.
7. **Diffuser**—Rabbit fits should be checked for foreign materials or damage.
8. **General**—All parts should be clean and free of burrs before assembly. This is especially important at O-ring grooves, threads, and bearing areas.

C. REASSEMBLY OF POWER END

Begin reassembly with the bearing frame.

Refer to instructions for the proper reassembly of individual bearing frames. See Section VI-A for identification of bearing frame.

J Frame

- a. Install ball bearing (112) on stub shaft (380) using a driving sleeve or bearing press.
- b. Lightly oil the bearing housing bore and outer race of the bearing. Install stub shaft assembly. This is a sliding fit when started properly; do not tap into place.
- c. Replace retaining ring (361E) in bearing frame with tapered side of ring away from bearing.
- d. Replace coupling hub (233) and key.

S Frame

- a. Clean the frame (228) and bearing end cover (109) and install the grease seal (333) with the lip out.
- b. The S frame uses angular contact (duplex) bearings mounted in the face-to-face configuration (thin edges of bearing outer race together). Install the bearings (112) on the stub shaft (380) so the thick outer race of the first bearing goes on first and thick outer race of the second bearing goes on last. Install the bearings using a driving sleeve or a bearing press. Drive inner race of bearing only.
- c. Thread the bearing locknut (136) on stub shaft (380) and tighten firmly.
- d. Place wave washer (529) in the bottom of the bearing frame (228).

- e. After lightly oiling the bearing housing bore and bearing outer races, install the stub shaft assembly. This is a sliding fit; do not tap in place.
- f. Install the bearing end cover (109) and gasket (360) and tighten bearing cap bolts (370N) evenly. The bearing cap should be installed with the *grease relief fitting* (113) *at the bottom*.
- g. Refer to lubrication instructions Section III-A to lubricate the bearings.
- h. Replace coupling hub (233) and key (400).

M, L, X, AND Y FRAMES

- a. Clean the frame (228A) and bearing end cover (109) and install the oil seals (332A, 333D) with the lips in.
- b. The M, L, X, and Y frames use a single deep groove radial bearing and either one (M Frame) or two (L, X, Y, frames) angular contact thrust bearings. The radial bearing (168A) has both outer race edges the same thickness. It is installed first on the stub shaft (380) (farthest from the motor). A bearing spacer (443) is then installed on the stub shaft (380). The single thrust bearing (112A) (M frame), or first of two thrust bearings (112A) (L, X, or Y frames), should then be mounted. These should be installed so the thin edge of the outer race points toward the radial bearing (168A) (toward the liquid end of the pump). For the L, X, and Y frame; the second thrust bearing (112A) is installed in the same direction. Drive inner race of bearing only.
- c. Thread the bearing locknut (136) on the stub shaft (380) and tighten firmly.
- d. Place wave washer (524) in bottom of bearing frame (228A).
- e. After lightly oiling the bearing frame bore and bearing outer races, install the stub shaft assembly. This is a sliding fit; do not tap in place.
- f. Install the bearing end cover (109A) and gasket (360) and tighten the bearing cap bolts (370N) evenly. Insure that the mark "TOP" in the bearing cap is *up*.
- g. Replace pump coupling hub (233) and key (400).

D. REASSEMBLY OF LIQUID END

1. Bolt seal housing (159) to bearing frame assembly.
2. Install O-rings (412L) on stationary seat mount (158). Lubricate O-rings well, and press seal seat mount into seal housing.
3. Install O-ring on stationary seat of mechanical seal (383B). Lubricate O-ring well and press stationary seat into stationary seat mount (158).
4. To install the drive collar (522) and split collet (524), slide the drive collar (522) over the shaft, past the long groove for the split collet (524), with the narrow end away from the splined end of the shaft. Spread the split collet (524) with a suitable tool, slide it on to the shaft with the narrow end away from the splined end of the shaft. Seat the split collet (524) into the long groove. Push the drive collar (522) over the split collet (524) and using a piece of pipe sized to seat against the narrow end of the drive collar (522), drive the drive collar (522) with a hammer over the split collet (524) until movement of the drive collar

(522) stops. The split collet (524) must still be in the groove butted against the edge closest to the splined end of the shaft. If the drive collar (522) split collet (524) are not positioned and seated properly as shown in figure 2, damage to the pump can occur when in operation.

5. Install mechanical seal retaining ring (361D) on shaft (122) in groove near splined end. On BP20 pumps only, this ring (361D) is not required as shaft has a retaining stepped shoulder.

6. Slide rotary unit of mechanical seal (383A) over splined end of pump shaft (122) and against retaining ring (361D). Use care to avoid cutting rubber bellows on spline teeth. On BP20 pumps, the mechanical seal shoulders against the step in shaft.

7. With bearing frame assembly in the vertical position, bolt casing adapter (108) to seal housing (159). Install O-ring (421K).

8. Slide splined end of pump shaft (122) into splined insert of stub shaft (380).

9. Install impeller key (178) in shaft (122).

10. Install back washer (546) on all impellers.

11. Install the suction diffuser (151) on the casing adapter (108). Be sure suction diffuser and casing adapter fits are clean and that the diffuser is free to turn in the casing adapter fit.

NOTE: Suction diffusers (150) on the BP20, BP40, BP70 and BP100 pumps are different than the other diffusers in each pump. In BP200 pumps, all diffusers are the same.

12. Install first stage impeller (201) on shaft (122). First stage impeller on the BP20 and 200 are the same as other impellers in pump. First stage impellers on BP40, BP70, and BP100 are different than other impellers in pump.

13. Set dial indicator as shown in Figure 3. Hold first stage impeller and shaft firmly in place and move suction diffuser up and down. The amount of movement as read on the dial indicator is the "Front Clearance" for this impeller. Add or subtract shims as necessary to obtain the required "Front Clearance". Required "Front Clearances" are listed in Table 1.

14. Continue adding diffusers and impellers. Shim each impeller to obtain the required front clearance.

15. Install spacer sleeves (157) after last impeller has been installed and its "Front Clearance" is set. Check space between end of last spacer sleeve (157) and snap ring groove at end of shaft. Add shims as necessary under the last spacer (157) until end of spacer covers approximately 1/2 of shaft retaining ring groove. Enter the shaft retaining ring over the shaft and press it down until it snaps in the groove.

16. Install O-rings (412K) on the discharge head (152) and diffusers with approximate spacing of every 16 stages for BP20 and every 8 stages for BP40 thru 200.

17. Slide casing (100) over assembly and screw onto casing adapter (108). O-rings should be lubricated to aid in assembly.

18. Screw discharge head (152) into casing (100).

19. Replace pump foot (131). Tighten cap screw (371U) finger-tight. Tighten after start-up when pump has reached operating temperature.

20. Lay pump in horizontal position. Place a heavy bar or pipe through the bearing frame to hold frame. Do not allow bar to contact stub shaft. THE DISCHARGE HEAD MUST BE TIGHTENED TO THE FOLLOWING MINIMUM TORQUE VALUES:

| | | |
|------------------------------|-------------|-------------------|
| BP20 | 400 ft-lbs. | 542 newton-metres |
| BP40, 70, 100, 200 series | 600 ft-lbs. | 813 newton-metres |

OPERATION OF PUMP WITHOUT PROPER TORQUE ON DISCHARGE HEAD (152) CAN RESULT IN DAMAGE TO THE PUMP.

21. Plug unused opening in seal housing. Openings are required only for special seals. Refer to seal drawing for special seals and flushing or cooling requirements.

22. Bolt motor to frame (228 or 228A). For NEMA 444 TCS and 445 TCS motors, an adapter is supplied.

23. Pump is now ready for reinstallation. Follow applicable installation, lubrication and start-up procedures.

D. BEARING AND SEAL REPLACEMENT

A. Bearing Replacement

1. Lock out power and remove motor from pump.
2. Support liquid end and remove the bearing frame assembly from the pump by removing cap screws (371L).
3. Follow instructions for the appropriate bearing frame for removal and replacement of bearings (See Section V-A and V-C).

B. Mechanical Seal Replacement

1. Lock out power and remove motor from pump. Remove bearing frame assembly from pump by removing cap screws (371L).
2. Access to seal is obtained by removing seal housing (159) and the stationary seat mount (158). Seal (383A) will then slide off shaft.
3. Slide new rotary unit over splined end of pump shaft (122) and against retaining ring (361D). Use care to avoid cutting rubber bellows on spline teeth. On BP20 pumps, the seal shoulders against the step in the shaft. When reassembling unit, be sure O-rings (412L) are not cut and that they are seated securely.
4. Refer to mechanical seal drawing for special seal arrangements.

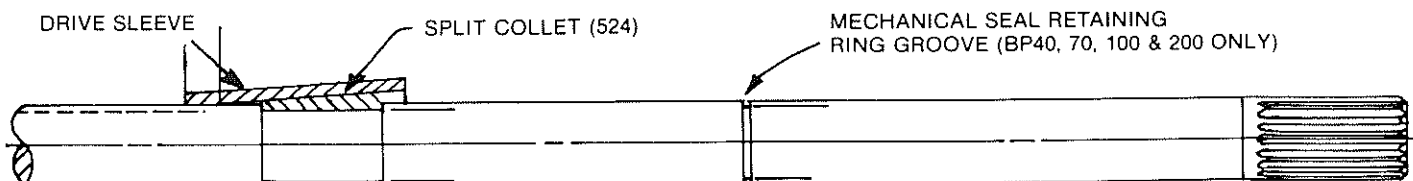

Figure 2

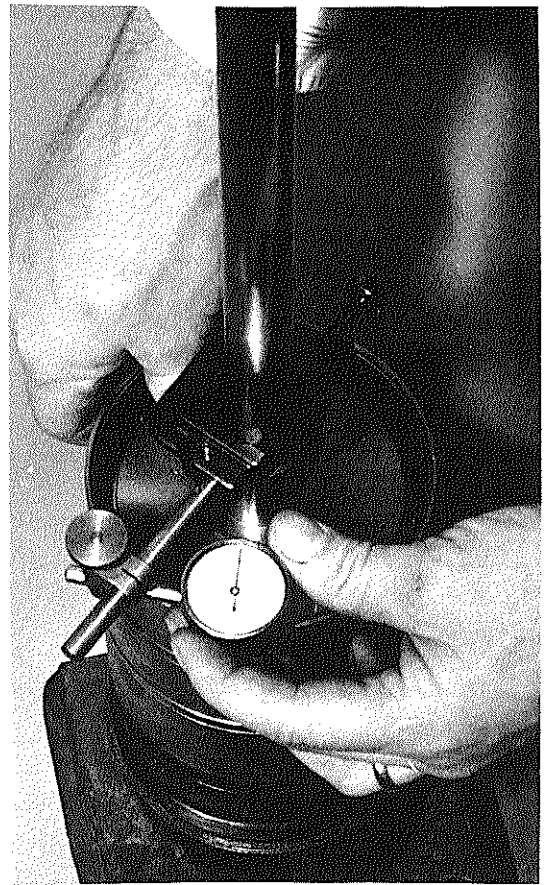
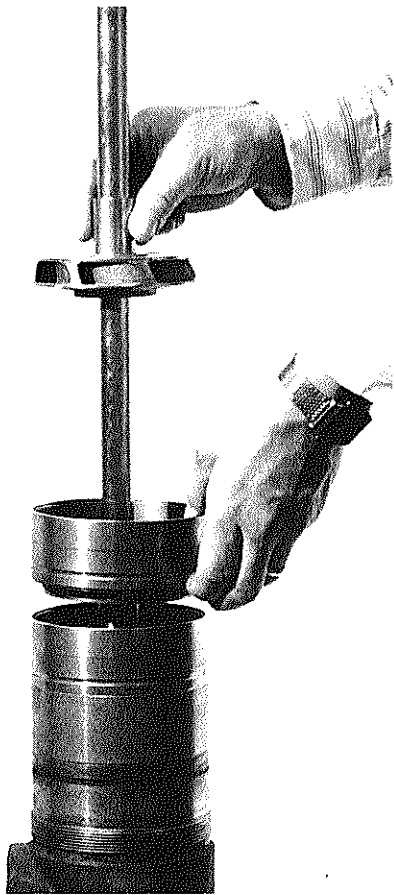

FIGURE 3

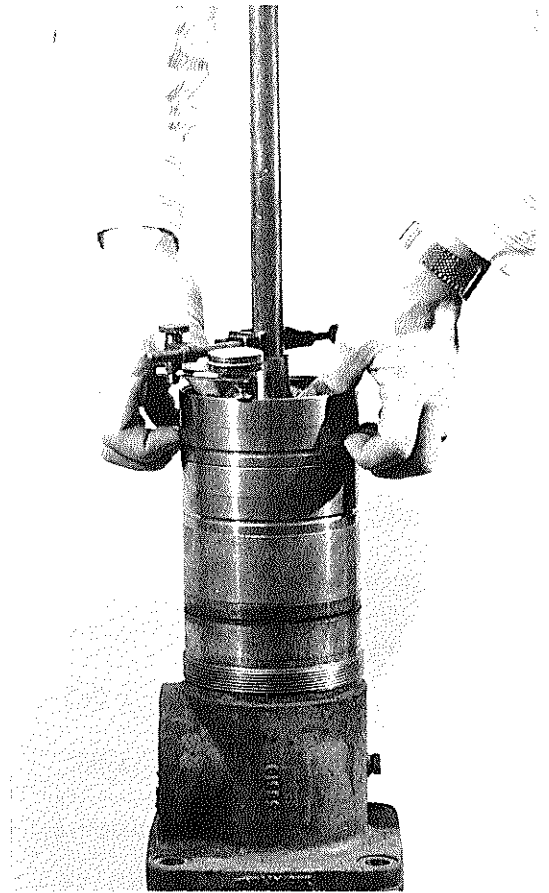

TABLE 1-20

| BP20 Impeller Stack | Required Front Clearance |
|----------------------------------|---------------------------------|
| 1st stack 14 stages or less | + .040" ± .005" |
| 2nd stack 15th to 20th stages | + .025" ± .005" |
| 3rd stack 29th to 42nd stages | + .030" ± .005" |
| 4th stack 43rd to 56th stages | + .035" ± .005" |
| 5th stack 57th to 70th stages | + .040" ± .005" |
| 6th stack 71st to 84th stages | + .045" ± .005" |
| 7th stack 85th stage | + .045" ± .005" |

- NOTE: 1. Steady bearings are located between each stack — every 14 stages.
 2. At completion of stacking remove .020" from front of impellers 21, 29, 35, 43, 49, 57, 63, 71, and 77.

TABLE 1-40

| BP40 Impeller Stack | Required Front Clearance |
|----------------------------------|---------------------------------|
| 1st stack 12 stages or less | + .040" ± .005" |
| 2nd stack 13th to 24th stages | + .025" ± .005" |
| 3rd stack 25th to 36th stages | + .025" ± .005" |
| 4th stack 37th to 39th stages | + .030" ± .005" |

- NOTE: 1. Steady bearings are located between each stack — every 12 stages.
 2. Use only .010" shims for setting front clearance of impellers 25 and 31.
 3. At completion of stacking remove one .010" shim from front of (suction side) impellers 25 and 31.

TABLE 1-70

| BP70 Impeller Stack | Required Front Clearance |
|-----------------------------------|---------------------------------|
| 1st stack 10 stages or less | + .040" ± .005" |
| 2nd stack 11th to 20th stages | + .020" ± .005" |
| 3rd stack 21st to 30th stages | + .020" ± .005" |
| 4th stack 31st to 40th stages | + .025" ± .005" |
| 5th stack 41st and 42nd stages | + .030" ± .005" |

- NOTE: 1. Steady bearings are located between each stack — every 10 stages.
 2. Use only .010" shims for setting front clearance of impellers 25, 31 and 35.
 3. At completing of stacking remove one .010" shim from front of (suction side) impellers 25, 31, and 35.

TABLE 1-100

| BP 100 Impeller Stack | Required Front Clearance |
|----------------------------------|---------------------------------|
| 1st stack 8 stages or less | + .040" ± .005" |
| 2nd stack 9th to 16th stages | + .020" ± .005" |
| 3rd stack 17th to 24th stages | + .020" ± .005" |
| 4th stack 25th to 32nd stages | + .025" ± .005" |
| 5th stack 33rd to 40th stages | + .030" ± .005" |
| 6th stack 41st stage | + .035" ± .005" |

- NOTE: 1. Steady bearings located between each stack — every 8 stages.
 2. Use only .010" shims for setting front clearance of impellers 21, 29, 33 and 37.
 3. At completion of stacking remove on .010" shims from front of (suction side) impellers 21, 29, 33 and 37.

TABLE 1-200

| BP200 Impeller Stack | Required Front Clearance |
|-----------------------------------|---------------------------------|
| 1st stack 4 stages | + .040" ± .005" |
| 2nd stack 5th to 8th stages | + .040" ± .005" |
| 3rd stack 9th to 12th stages | + .040" ± .005" |
| 4th stack 13th to 16th stages | + .025" ± .005" |
| 5th stack 17th to 20th stages | + .025" ± .005" |
| 6th stack 21st to 24th stages | + .025" ± .005" |
| 7th stack 25th to 28th stages | + .025" ± .005" |
| 8th stack 29th to 32nd stages | + .025" ± .005" |
| 9th stack 33rd to 36th stages | + .030" ± .005" |
| 10th stack 37th to 40th stages | + .030" ± .005" |
| 11th stack 41st to 44th stages | + .030" ± .005" |
| 12th stack 45th to 48th stages | + .030" ± .005" |

- NOTE: 1. Steady bearing located between each stack — every 14 stages.
 2. At completion of stacking, remove on .020" shim from front of (suction side) impeller 41.

SECTION VI—ENGINEERING

A. SECTIONAL VIEW

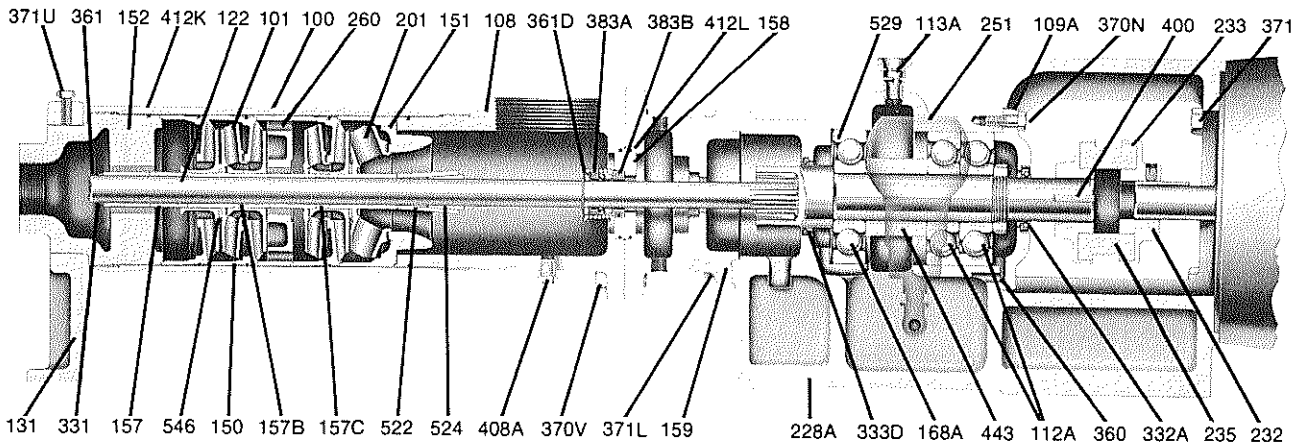

J Frame

A greased-for-life medium duty Conrad bearing carries thrust loads developed by the low pressure BP20 series pumps. The maximum HP motor able to be mounted on the J frame is the NEMA 3 HP ODP.

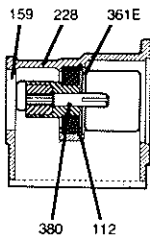

S Frame

Two angular contact bearings mounted face-to-face carry low to medium duty thrust loads in this regreaseable bearing frame. NEMA motors from 3 HP TEFC to 25 HP ODP can be mounted on this bearing frame.

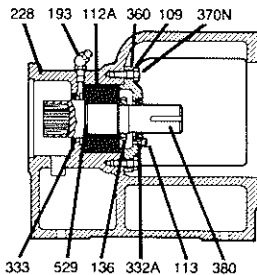

M Frame

A single angular contact bearing carries medium to heavy thrust loads and provides oil lubrication for pumps requiring NEMA motors from 3 HP TEFC to 25 HP ODP.

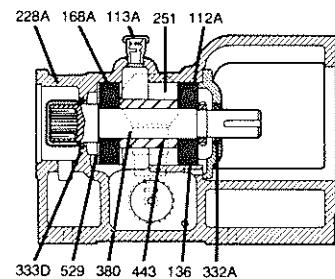

L & X Frames

The oil lubricated L frame provides high thrust capability as encountered in high discharge pressure applications with tandem mounting of angular contact bearings. The L frame takes the same motor sizes as the S and M frames. On the X frame, an angular contact, tandem bearing arrangement identical to the L frame carries high thrust loads and extends NEMA motor capability from 25 HP TEFC to 40 HP ODP.

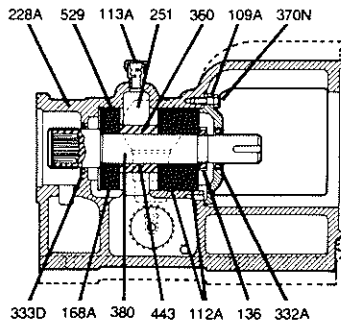

Y Frame

Foot mounted industrial NEMA motors from 40 HP TEFC through 150 HP TEFC are mounted on the Y frame. The inherent high thrusts encountered in high pressure applications are carried by an angular contact tandem bearing arrangement. Pump mounting is accomplished by utilizing the motor feet rather than integral mounting pads on the bearing frame.

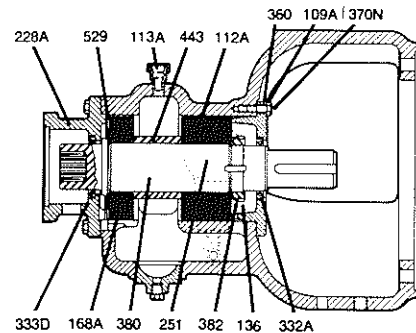

B. PARTS LIST AND MATERIALS OF CONSTRUCTION

| Power End | | | | | | | | |
|-----------|---|-------------------|--------------------|---------|-----------------|--------|--------|--------|
| Item No. | Part Name | Material | Grease Lubrication | | Oil Lubrication | | | |
| | | | J | S | M | L | X | Y |
| 109 | Bearing End Cover | Cast Iron | — | S | — | — | — | — |
| 109A | Bearing End Cover | Cast Iron | — | — | M | L | X | Y |
| 109C | Bearing End Cover Radial | Cast Iron | — | — | — | — | — | Y |
| 112 | Ball Bearing, Thrust | Steel | 308SZZ | 7308PDF | — | — | — | — |
| 112A | Ball Bearing, Thrust | Steel | — | — | 7408DT | 7408DT | 7408DT | 7313DT |
| 113 | Grease Relief Fitting | Steel/Cad Plate | — | S | — | — | — | — |
| 113A | Breather | Steel/Zinc Plate | — | — | M | L | X | Y |
| 123 | Deflector (Not Shown) | Lam Plastic | — | — | — | — | — | Y |
| 131 | Pump Foot (BP20 Only) | Cast Iron | J | S | M | L | X | — |
| 131 | Pump Foot (Except BP20) | Cast Iron | — | S | M | L | X | Y |
| 136 | Bearing Lock Nut | Steel | — | S | M | L | X | Y |
| 168A | Ball Bearing Coupling End | Steel | — | — | 408S | 408S | 408S | 313S |
| 193 | Grease Fitting | Steel/Zinc Plate | — | S | — | — | — | — |
| 228 | Frame—Grease Lube | Cast Iron | J | S | — | — | — | — |
| 228A | Frame—Oil Lube | Cast Iron | — | — | M | L | X | Y |
| 232 | Coupling Hub—Motor | Die Metal | J | S | M | L | X | Y |
| 233 | Coupling Hub—Pump | Die Metal | J | S | M | L | X | Y |
| 235 | Coupling Sleeve | Rubber ** | J | S | M | L | X | Y |
| 251 | Sight Oiler | White Metal/Glass | — | — | M | L | X | Y |
| 332 | Grease Seal—Bearing Cover | Buna-N | — | S | — | — | — | — |
| 332A | Oil Seal—Bearing Cover | Buna-N | — | — | M | L | X | Y |
| 333 | Grease Seal—Frame | Buna-N | — | S | — | — | — | — |
| 333D | Oil Seal—Frame | Buna-N | — | — | M | L | X | Y |
| 360 | Gasket End Cover | Vellumoid | — | S | M | L | X | Y |
| 361E | Retaining Ring—Bearing | Steel | J | — | — | — | — | — |
| 370B | H Cap Screw, Frame to Adapter (Not Shown) | Steel | — | — | — | — | — | ▲Y |
| 370N | H Cap Screw—End Cover | Steel | — | S | M | L | X | Y |
| 371 | H Cap Screw—Frame to Motor | Steel | J | S | M | L | X | Y |
| 371U | H Cap Screw—Pump Foot Retaining | Steel | J | S | M | L | X | Y |
| 380 | Stub Shaft | Steel | J | S | M | L | X | Y |
| 382 | Bearing Lock Washer | Steel | — | — | — | — | — | Y |
| 389 | Motor Adapter (Not Shown) | Cast Iron | — | — | — | — | — | ▲Y |
| 400 | Coupling Key | Steel | J | S | M | L | X | Y |
| 443 | Bearing Spacer | Steel | — | — | M | L | X | Y |
| 529 | Wave Washer | Steel | — | S | M | L | X | Y |

Liquid End

| Item No. | Part Name | Material |
|----------|--|-----------------------------------|
| 100 | Casing | Carbon Steel |
| 101 | Impeller | NI-Resist Type 1 |
| 108 | Casing Adapter | NI-Resist Type 2 |
| 122 | Shaft | K-Monel |
| 150 | Diffuser | NI-Resist Type 1 |
| 150A | Spacer Blank (Not Shown) | NI-Resist Type 2 |
| 151 | Suction Diffuser | NI-Resist Type 2 |
| 152 | Discharge Head | NI-Resist Type 2 |
| 157 | Spacer Sleeve | 316 SS |
| 157B | Intermed. Brg. Shaft Sleeve | 316 SS |
| 157C | 1st Stage Shaft Sleeve | 316 SS |
| 158 | Stationary Seat Mount | NI-Resist Type 2 |
| 159 | Seal Housing | NI-Resist Type 2 |
| 178 | Impeller Key (Not Shown) | Monel Alloy 400 |
| 188* | Cooling Jacket (Not Shown) | NI-Resist Type 2 |
| 201‡ | Impeller, First Stage | NI-Resist Type 1 |
| 260 | Intermediate Bearing | NI-Resist Type 1 Carbon Insert |
| 331 | Shim | 304 SS |
| 361 | Retaining Ring, Shaft | 303 SS |
| 361D* | Retaining Ring, Mech Seal | 303 SS |
| 370V | H Cap Screw-Adapter to Seal Housing | Steel |
| 371L | H Cap Screw-Seal Housing to Frame | Steel |
| 383A | Rotary Element | 18-8 SS-Viton |
| 383B* | Stationary Seat (XP171) | NI-Resist & Viton |
| 383B | Stationary Seat (XP1D1) | Carbide & Viton |
| 408A | Pipe Plug-Drain | Brass |
| 412J* | O-Ring Cooling Jacket (Not Shown) | Viton |
| 412K | O-Ring Casing | Viton |
| 412L | O-Ring Stationary Seat Mount | Viton |
| 473* | Restricting Bushing (Cooling Jacket) (Not Shown) | Carbon |
| 522 | Drive Collar | 316 SS |
| 524 | Split Collet | 316 SS |
| 546 | Washer-Back | Glass-Moly-Teflon |

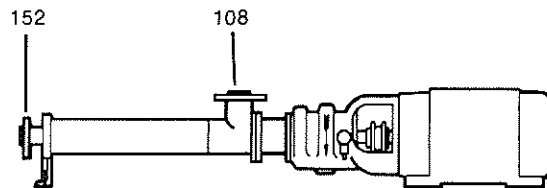

Optional Flanged Construction

| Item No. | Part Name | Material |
|----------|----------------|-------------------|
| 108 | Casing Adapter | Cast Carbon Steel |
| 152 | Discharge Head | Cast Carbon Steel |

*Optional ▲For 444TSC and 445TSC Motors Only ‡BP40, 70 & 100 Only **Steel on Y Frame

C. PRESSURE/TEMPERATURE CAPABILITY

| Pressure | Working Pressure | 1500 PSI Maximum (105 kg/cm ²) | |
|-------------|--------------------------|--|------------------|
| | Suction Pressure | 400 PSI Maximum (28 kg/cm ²) | |
| Temperature | W/O Seal Housing Cooling | J and S Frames (Grease Lube) | to 250°F (120°C) |
| | | L, M, X & Y Frames (Oil Lube) | to 300°F (149°C) |
| | W/Seal Housing Cooling | All Frames | to 400°F (204°C) |

SECTION VII—TROUBLE SHOOTING

| PROBLEM | POSSIBLE CAUSES & CORRECTION |
|---|---|
| A. No Liquid delivered, not enough liquid delivered, or not enough pressure | 1, 2, 3, 4, 5, 6, 7, 8, 9, 10, 11, 12, 13, 14, 17, 22, 23 |
| B. Pump works a while then quits | 4, 5, 7, 8, 9, 11, 12, 22, 23 |
| C. Pump takes too much power | 15, 18, 19 |
| D. Pump is noisy or vibrates | 15, 16, 20, 21, 23, 24 |
| E. Pump leaks excessively at seal housing | 8 |
| F. High bearing temperature | 23, 24, 25 |

CAUSES & CORRECTIVE MEASURES

1. Pump not primed or properly vented—check that casing and suction pipe are completely filled with liquid.
2. Speed too low—check whether or not motor wiring is correct and receives full voltage, or turbine receives full steam pressure.
3. System discharge head too high—check system head (particularly friction losses).
4. Suction lift too high—check NPSH available (suction piping too small or too long may cause excessive friction losses). Check with vacuum or compound gauge.
5. Pump or piping obstructed—check for obstructions.
6. Wrong direction of rotation—check rotation.
7. Air pocket or leak in suction line—check suction piping for air pockets and/or air leaks.
8. Incorrect or damaged seal allowing leakage of air into pump casing or liquid leakage out—inspect seal or replace as required.
9. Not enough suction head for hot or volatile liquids—increase suction head, consult factory.
10. Foot valve too small—install correct size foot valve.
11. Foot valve or suction pipe not immersed deep enough—consult factory for proper depth. Use baffle to eliminate vortices.
12. Entrained air or gases in liquid—consult factory.
13. Impeller clearance too great—check for proper clearance.
14. Impeller damaged—inspect and replace as required.
15. Rotating parts bind—check internal wearing parts for clearances.
16. Coupling or pump and driver misaligned—check alignment and realign if required.
17. Improper pressure gauge location—check correct position and discharge nozzle or pipe.
18. Head lower than rating: pumps too much liquid—consult factory. Install throttle valve.
19. Liquid heavier than anticipated—check specific gravity and viscosity.
20. Cavitation—increase NPSH available. Consult factory.
21. Improper bearing lubrication or bearings worn out—inspect and replace as required.
22. Internal recirculation due to damaged diffusers or diffuser O-rings—Replace damaged diffusers and O-rings.
23. Diffusers spinning, due to insufficient torque on discharge head—Replace damaged diffusers and reassemble with proper torque on discharge head.
24. Pump not properly secured to base or piping not properly supported—provide for secure bolting to base, proper base structure and support of pipes.
25. Incorrect bearing frame oil level (high or low) or lack of grease—follow lubrication instructions.

SECTION VIII—SPARE PARTS

A. ORDERING SPARE PARTS

To insure against possible long and costly downtime periods, especially on critical services, it is advisable to have spare parts on hand. The most desirable parts to have on hand are the following:

1. Ball Bearings. Replacement angular contact thrust bearings must have races properly ground for the appropriate mounting configuration. Angular contact bearings which are universally ground may be mounted in tandem, back-to-back, or face-to-face configuration. The mounting configuration

(face-to-face for the S frame, and tandem for L, X, Y) should be specified when replacement bearings are ordered from local sources to assure proper grinding of outer races.

2. Oil Seals.
3. Bearing locknut.
4. Bearing lock washer (Y frame only).
5. Mechanical Seal.
6. Casing O-ring.
7. Back washers.
8. O-rings for seal seat, seal mount, casing and

diffusers.

Also desirable, but more dependent on plant practice, is either of the following:

- a. Complete set of impellers, diffusers, and thrust washers for the pump, or:
- b. Spare liquid end consisting of everything but the bearing frame.

B. INSTRUCTIONS FOR ORDERING SPARE PARTS

Repair orders will be handled with the minimum of problems if the following information is accurately supplied:

- 1. Nameplate Data
 - a. Pump Serial Number
 - b. Pump Model Number
 - c. Pump Size.
 - d. Pump Construction
- 2. Order Data
 - a. Part Name.

- b. Part Number (item number). These names and numbers should agree with those on the Sectional View found in Section VI.

3. Explanation of Pump Nameplate designation

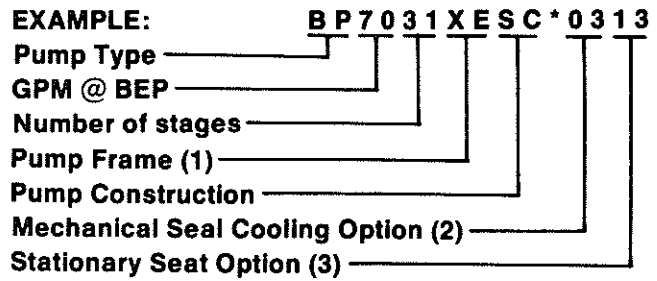

(1) The first letter of this group (X) indicates the pump frame, the second letter indicates the coupling and stub shaft combination.

(2) Option 03 is less seal cooling, while 04 designates cooling option furnished.

(3) Option 13 is the standard NI-Resist stationary seat, while option 12 is the tungsten carbide seat.



No. 139
April 5, 1982

SUBJECT : Model 3333, 3335 & 3935

MODIFICATION : Relocation of Oiler on Model 3333-3335-3935 Oil Lube Frames

HISTORY : The oiler on Model 3333-3335-3935 oil lube frames was piped to the frame as shown below. Variation in the length of the vertical pipe nipple; variation in thread engagement between nipple, elbow and oiler; or use of an incorrect nipple could cause unpredictable changes in oil level.

DESCRIPTION : Additional tapped openings have been added to the frame. The oiler is piped to the frame using only one nipple, as shown below. Internal setting of the oiler is unchanged.

This is a running change effective immediately.

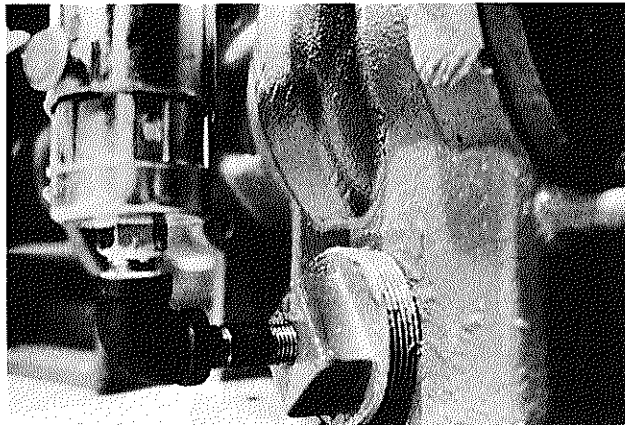

OLD DESIGN

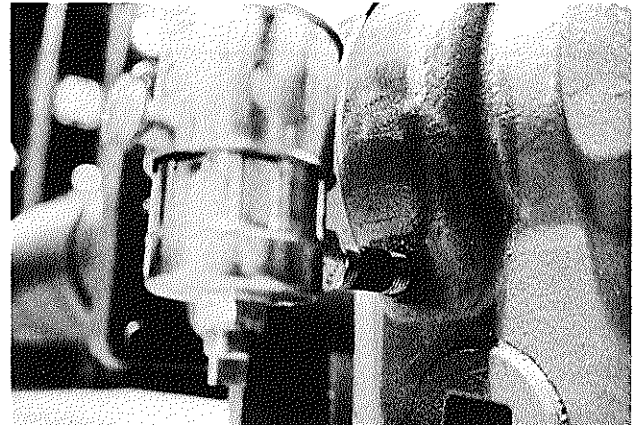

NEW DESIGN

A pump is only as good as its parts.

The Goulds pump featured in this instruction manual is made up of many different parts. All are engineered and precision manufactured to make the pump perform as intended. Therefore it's *most important* to make sure that you use only genuine Goulds replacement parts.

To assure that you can make no better choice than Goulds, we offer the best pump parts program in the industry. We call it "pump parts like never before" and very simply means unsurpassed *availability, service, quality and value.*

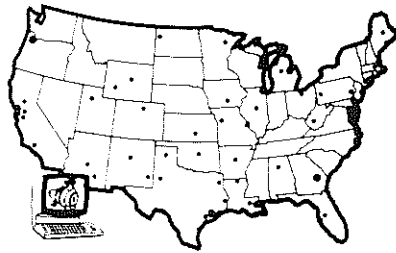

Availability A nationwide, computer-controlled distribution network backed by factory programs designed to get you the part you need — when you need it.

Service Our Certified Original Parts specialists are dedicated to serving your parts needs by:

- Helping minimize parts inventories
- Delivering parts
- Providing maintenance consultation service

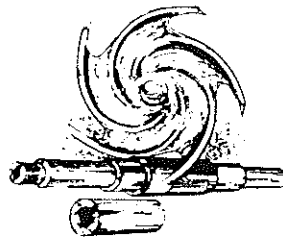

Quality Goulds is committed to providing the highest *original* quality and sometimes *better* if design or material improvements have been made.

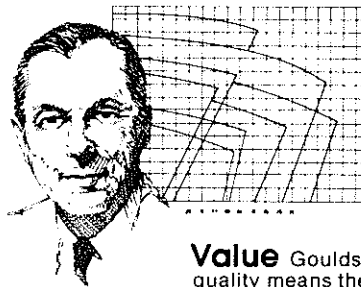

Value Goulds high standards of quality means the part will fit right and meet original standards of performance.

GOULDS PUMPS
© PARTS
THE REAL ONES