



ITT

Goulds Pumps

Goulds 3198 *i-FRAME*[™]

PFA Teflon[®]-Lined Process Pumps



Engineered for life

3198 *i-FRAME* STi

The 3198 *i-FRAME* PFA Teflon[®]-lined process pump line is specifically designed to provide superior performance for low flow services of the Chemical Process Industries.

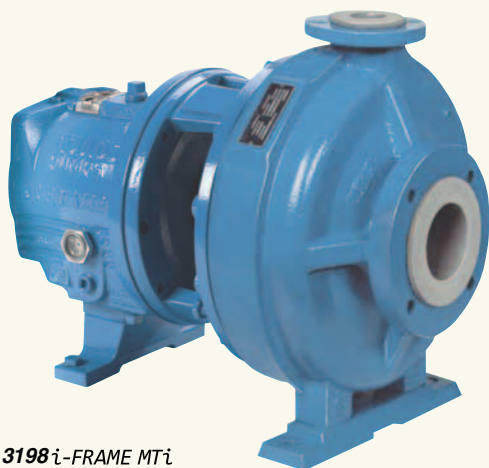
3198 *i-FRAME* MTi

Goulds 3198 *i-FRAME*[™]

PFA Teflon[®]-Lined Process Pumps Designed for Total Range of Severe Corrosive Services

- ◆ Capacities to 800 GPM (182 m³/h)
- ◆ Heads to 450 feet (137 m)
- ◆ Temperatures to 300° F (149° C)
- ◆ Pressures to 225 PSIG (1552 kPa)

Performance Features for Severe Corrosive Services

Extended Pump Life

- ◆ Virgin PFA Teflon[®] lining
 - Optimum lining thickness
 - Superior corrosion resistance
- ◆ *i-FRAME* Power Ends
- ◆ Fully open impeller

Ease of Maintenance

- ◆ Back pull-out design
- ◆ External impeller adjustment
- ◆ Parts interchangeable with Goulds 3196 *i-FRAME*
- ◆ Easy retrofit
- ◆ ANSI standard dimensions

Safety

- ◆ ANSI B15.1 coupling guard
- ◆ Ductile iron frame adapter

Services

- ◆ Hydrochloric acid
- ◆ Hydrofluoric acid
- ◆ Ferric chloride
- ◆ Pickling acid
- ◆ Plating acid
- ◆ Plating solutions
- ◆ Chlorinated brine
- ◆ Chlorinated hydrocarbons
- ◆ Sodium hypochlorite
- ◆ Chlorine dioxide

Goulds 3198 *i-FRAME*™ Designed for Severe Corrosive Services



TEFLON IMPELLER



ALLOY IMPELLER

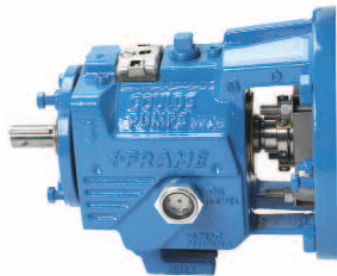

i-FRAME POWER END



GLAND

BACKPLATE



IMPELLER



CASING

Goulds 3198 *i-FRAME*...An Economical Solution

For severe corrosive services, users have traditionally specified pumps constructed of exotic alloys such as titanium, zirconium and monel. The high cost of these alloys, plus the difficulty in making the proper selection, have prompted pump users to seek alternatives.

The 3198 *i-FRAME* is an economical solution. For less than the price of an exotic alloy ANSI process pump, the 3198 *i-FRAME* can be reliably used for handling a wide range of severe corrosives.

The 3198 *i-FRAME* is constructed for optimum reliability. Every day it proves itself in demanding installations, standing up to tough services – and lasting!

Virgin PFA Teflon®-Lined Construction

Corrosion Resistance

The PFA Teflon® lining is resistant to most industrial chemicals and solvents with the exception of molten alkali metals and related compounds. It's the acknowledged material of choice for handling severe corrosives.

Outstanding Strength

Ductile iron and carbon steel backing provide strength equal to all-metal pump components. Outstanding strength reduces the effect of pipe loads on shaft alignment (flange loading capability is the same as all-metal 3196).

True volute casing provides performance and efficiencies similar to the standard of the industry—Goulds 3196.

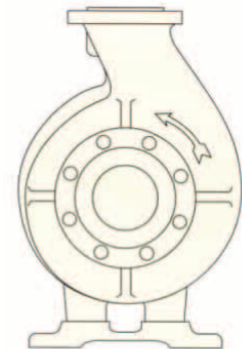

Bonus Interchangeability

i-FRAME™ Power Ends Fit 7 Different Process Pumps

Minimize inventory, reduce downtime.



3196
Chemical
Process Pumps



CV 3196
Non-Clog
Process Pumps



HT 3196
High-Temperature
Chemical Process Pumps



LF 3196
Low Flow ANSI
Process Pumps



3198
PFA TEFLON®-Lined
Process Pumps



3796
Self-Priming
Process Pumps



3996
In-Line Process Pumps

Maximum Sealing Flexibility

A wide range of sealing arrangements are readily available to meet specific user requirements.

Your Goolds representative can recommend the best solution for any service. Some are illustrated here.

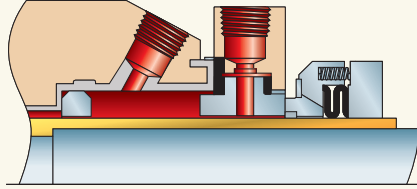

- SINGLE OUTSIDE SEAL**
- Stuffing box design
 - Flush gland
 - By-pass flush

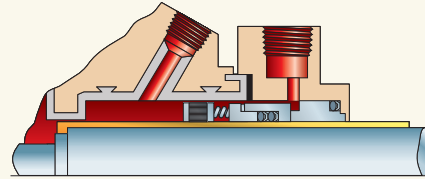

- CONVENTIONAL SINGLE SEAL**
- Stuffing box design
 - Flush gland
 - By-pass flush

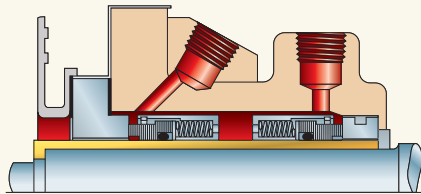

- CONVENTIONAL DOUBLE SEAL**
- Backplate design
 - Seal chamber
 - External flush or CPI Plan 7353

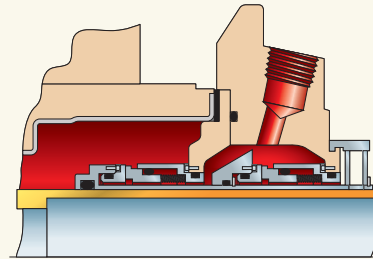

- DOUBLE CARTRIDGE SEAL**
- BigBore™ seal chamber
 - Flush gland
 - Tefzel® Lined

Goolds *i-FRAME*™ Power Ends Designed for Reliability, Extended Pump Life

Condition Monitor

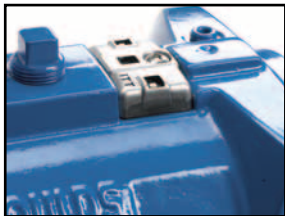

The heart of the *i-FRAME*, the condition monitor unit continuously measures vibration and temperature at the thrust bearing and automatically indicates when pre-set levels of vibration and temperature have been exceeded, so that changes to the process or machine can be made before failure occurs.

A visual indication of pump health makes walk-around inspections more efficient and accurate. The result is a more robust process to monitor and maintain all your ANSI pumps so that your plant profitability is maximized.

Shaft and Bearings Engineered for Maximum Reliability

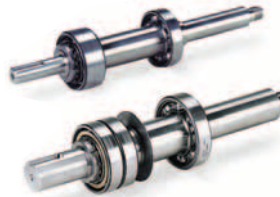

Fatigue life *more than double* that of conventional bearing steels.

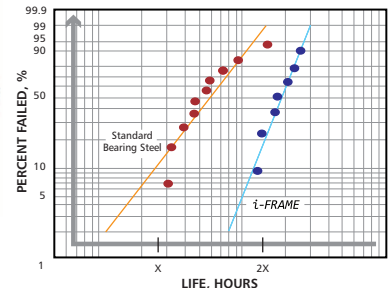

Inpro VBXX-D Hybrid Bearing Isolators

Most bearings fail before reaching their potential life. They fail for a variety of reasons, including contamination of the lubricant. INPRO VBXX-D has long been considered the industry standard in bearing lubricant protection. The *i-FRAME* now improves upon that design by offering stainless steel rotors, for maximum protection against contaminants and the corrosive effects of seal leakage or environmental conditions. These seals are non-contacting and do not wear.

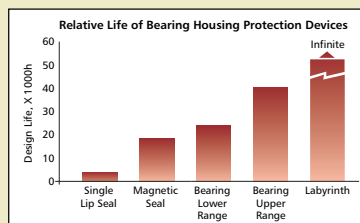

Optimized Oil Sump Design

Internal sump geometry is optimized for longer bearing life. Sump size increased by 10%-20% results in better heat transfer and cooler bearings. Contoured design directs contaminants away from bearings, to the magnetic drain plug for safe removal.

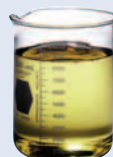
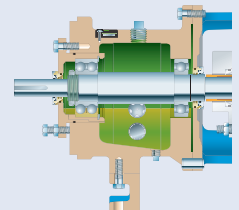

Larger Means Cooler
 GOOLDS
 Industry Average

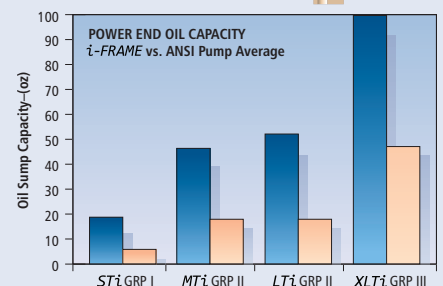



3198 *i*-FRAME™ Teflon® Process Pumps Design Features for Wide Range of Severe Corrosive Services

CONDITION MONITOR (Patent Pending)

Constantly measures vibration and temperature at the thrust bearing. Colored LED's indicate general pump health. Provides early warning of improper operation before catastrophic failure occurs.

INPRO VBXX-D HYBRID LABYRINTH SEALS

Prevents premature bearing failure caused by lubricant contamination or loss of oil. Stainless steel rotors for optimal performance in corrosive environments

CONTINUOUS HIGH PERFORMANCE

Original high efficiency maintained by simple external adjustment resulting in long-term energy savings.

HEAVY DUTY SHAFT AND BEARINGS

Shaft designed for minimum deflection – less than .002 in. (.05 mm) – at seal faces. Bearings sized for 2-year minimum and 10-year average life under tough operating conditions.

ONE-INCH OIL SIGHT GLASS

For easy monitoring of actual oil level and condition.

SHAFT SEALING

Goulds 3198 is available with backplate, stuffing box, or BigBore™ seal chamber. Accommodates conventional single inside, single outside, and double mechanical seals. BigBore™ seal chamber accommodates cartridge single and double seals.

RIGID FRAME (AND CASING) FEET

Reduce the effect of pipe loads on alignment.

i-FRAME POWER END

Designed for reliability and extended pump life, backed with a 5-year warranty.

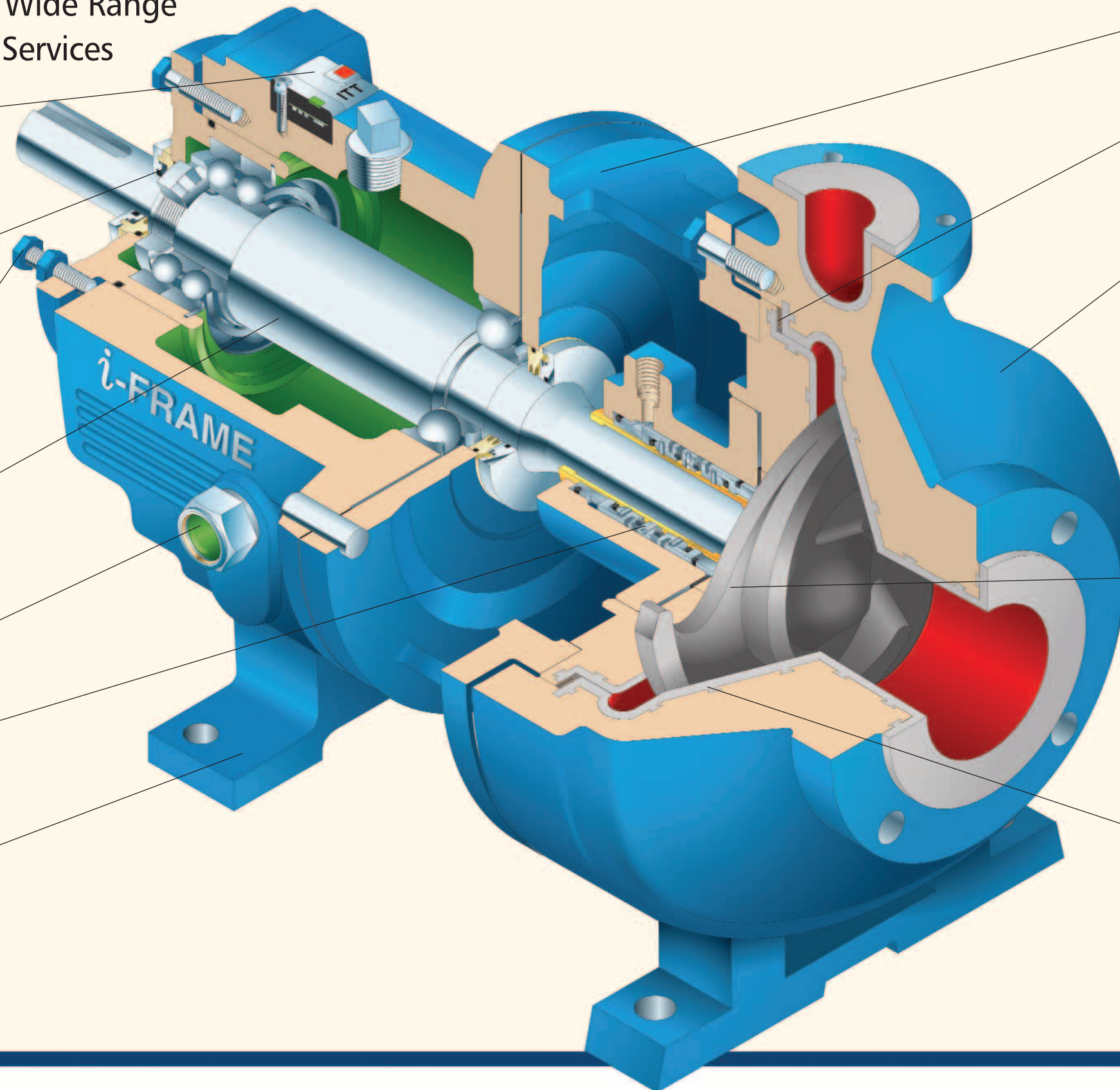

DUCTILE IRON FRAME ADAPTER

Material strength equal to carbon steel for safety.

POSITIVE SEALING

Assured by renewable, confined Teflon® envelope casing gasket. Compressible filler assures positive seal with low bolt load and without need for retightening.

CIRCULAR VOLUTE CASING

Reduces radial loads during low flow operation. Mechanical seal and bearings last longer. Fully machined discharge and volute provide maximum efficiency and precise control of hydraulics at low flows.



FULLY OPEN IMPELLER

Acknowledged best design for chemical services – solids handling, stringy material, corrosives, abrasives. Back pump-out vanes minimize seal chamber pressure.

Impeller inserts provide uniform low-stress torque transfer and maximum PFA Teflon® material support. Assures close tolerance impeller-to-shaft alignment and fit. Metal-to-metal impeller drive.

Teflon® impeller O-ring in controlled compression protects threaded area against corrosion

THICK PFA TEFLON

Molded in place to ductile iron by high pressure molding technique and mechanically dovetail locked. PFA Teflon® is stress relieved to eliminate cracking.

Hydraulic Coverage 3198 i-FRAME™

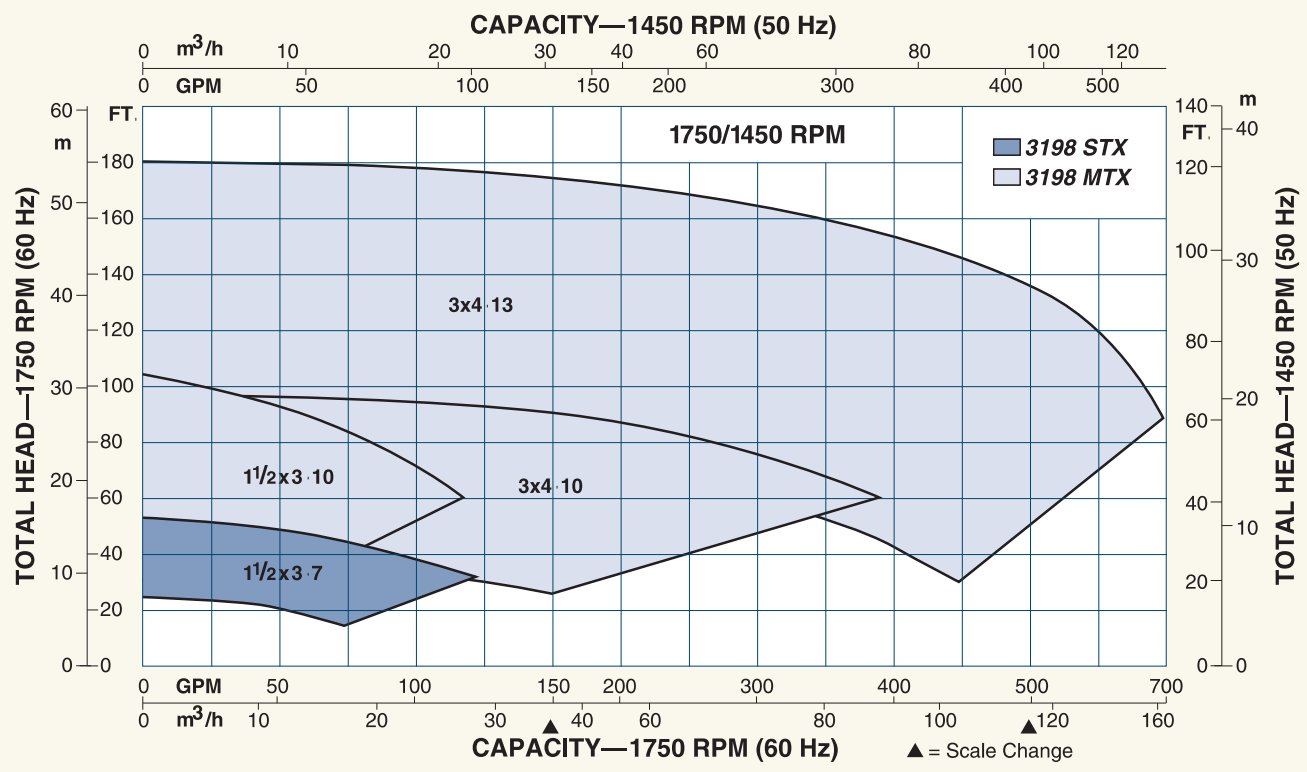
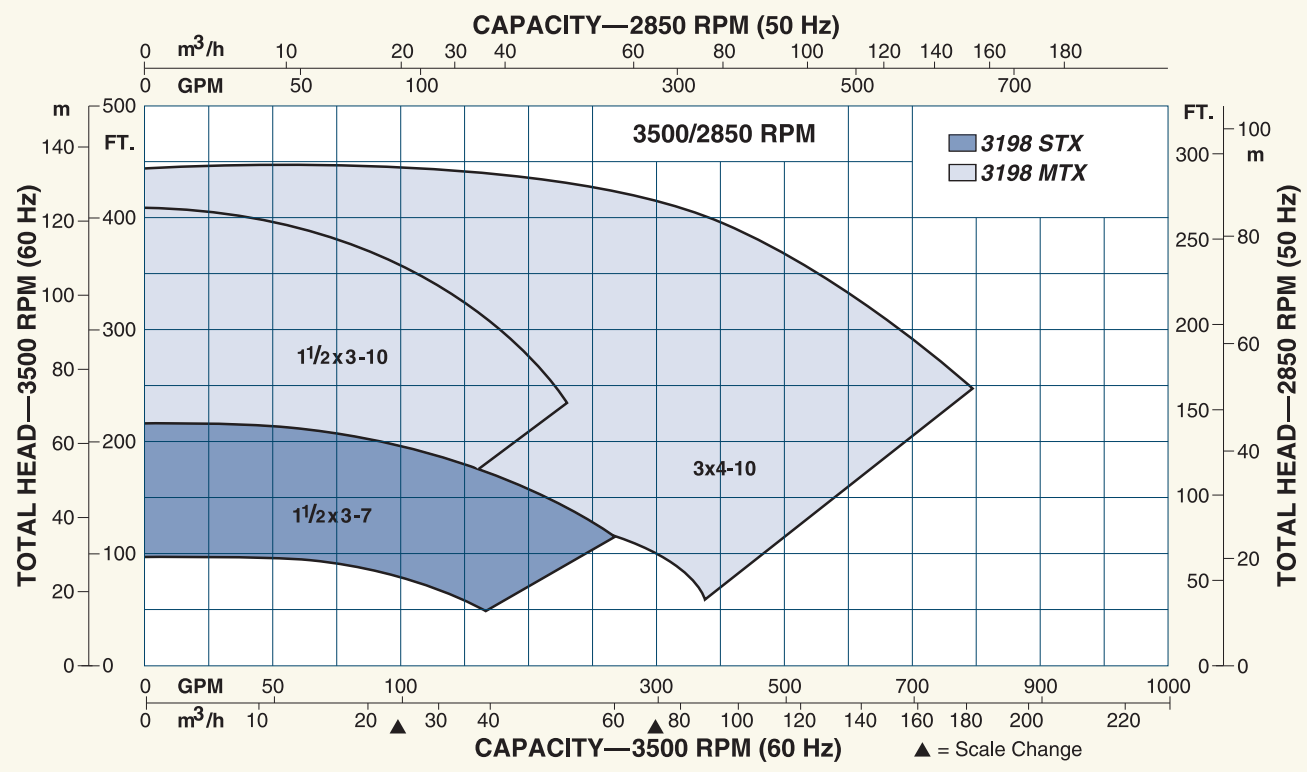

Parts List and Materials of Construction

Item Number	Part Name	Material
100	Casing	PFA Teflon® Lined Ductile Iron
101	Impeller (with insert)	PFA Teflon® Lined Steel
108	Frame Adapter	Ductile Iron
112	Thrust Bearing	Double Row Angular Contact
122	Shaft	316SS (Standard) Optional: Alloy 20, Hastelloy B & C
126	Shaft Sleeve	Choice: PFA Teflon®, 316SS, Alloy 20, Hastelloy B & C, Titanium, Zirconium
136	Bearing Locknut and Washer	Steel
159	Seal Chamber (Backplate Design)	316SS
168	Radial Bearing	Single Row Deep Groove
228	Bearing Frame	Cast Iron (Ductile Iron for STX)
319	Oil Sight Glass	Glass/Steel
332A	Labyrinth Seal (Outboard)	Stainless Steel/Bronze
333A	Labyrinth Seal (Inboard)	Stainless Steel/Bronze
351	Casing Gasket	Teflon® Envelope
356A	Stud–Casing to Frame or Frame Adapter	316SS
360	Gasket–Frame to Adapter	Vellumoid
370H	Stud and Nut–Backplate/Frame or Frame Adapter	304SS
383	Mechanical Seal	(As Specified)
418	Jacking Bolt	304SS
444	Backplate	PFA Teflon® Lined Ductile Iron
469B	Dowel Pin	Steel
496	O-ring—Bearing Housing	Buna Rubber
496A	O-ring—Impeller	PFA Teflon®
761B	Condition Monitor	Stainless Steel/Epoxy

Construction Details All dimensions in inches and (mm).

		3198 <i>STi</i>	3198 <i>MTi</i>
Lining Thickness	Casing	3/16 (4.8)	
	Impeller	1/8 (3.2)	
	Stuffing Box Cover	3/16 (4.8)	
	Backplate	3/16 (4.8)	
	Shaft Sleeve	1/8 (3.2)	
Shaft	Diameter at Impeller	.75 (19)	1 (25)
	Diameter in Seal Chamber (Less Sleeve) (With Sleeve)	1.375 (35)	1.75 (45)
		1.125 (29)	1.5 (38)
	Diameter Between Bearings	1 1/2 (38.1)	2 1/2 (54)
	Diameter at Coupling	3/4 (22.2)	1 1/4 (28.6)
	Overhang	6.125 (156)	8.375 (213)
Maximum Shaft Deflection	0.002 (0.05)		
Sleeve	Outer Diameter thru Seal Chamber	1 1/4 (34.9)	1 1/4 (44.5)
Bearings	Radial	SKF6207	SKF6309
	Thrust	SKF5306	SKF5309 A/C3
	Bearing Span	4.125 (105)	6.75 (171)
Seal Chamber	Bore	2.1 (53)	2.6 (66)
Power Limits	HP (kW) per 100 RPM	1.1 (.82)	3.4 (2.6)
Maximum Liquid Temperature	Oil/Grease Lubrication	300°F (150°C)	

Sectional View 3198 *i*-FRAME™

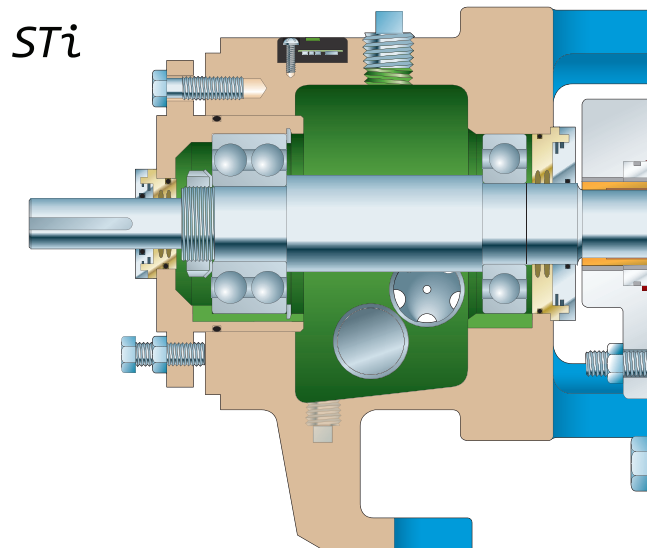
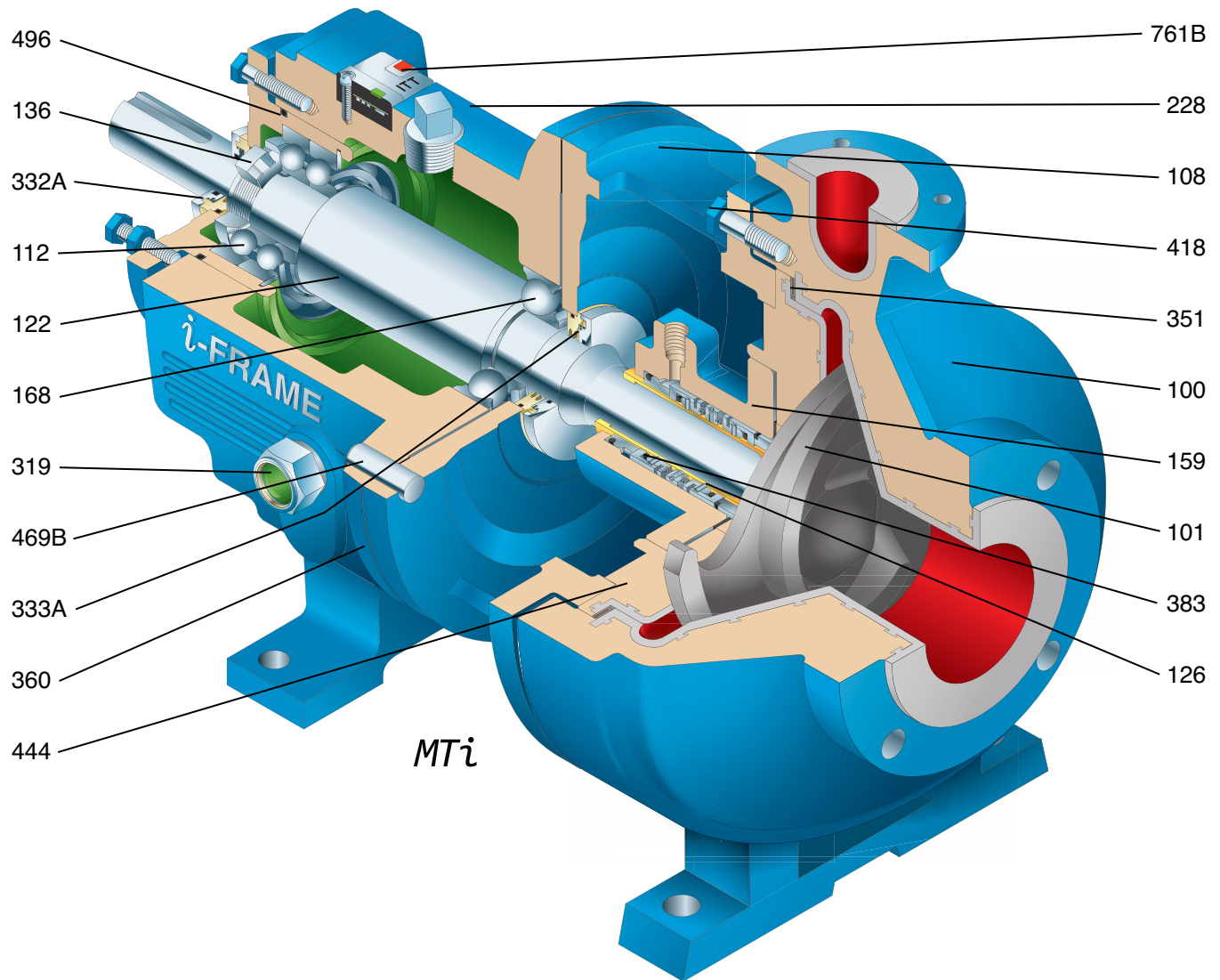

Dimensions Models 3107/3198 i-FRAME™

All dimensions in inches and (mm). Not to be used for construction.

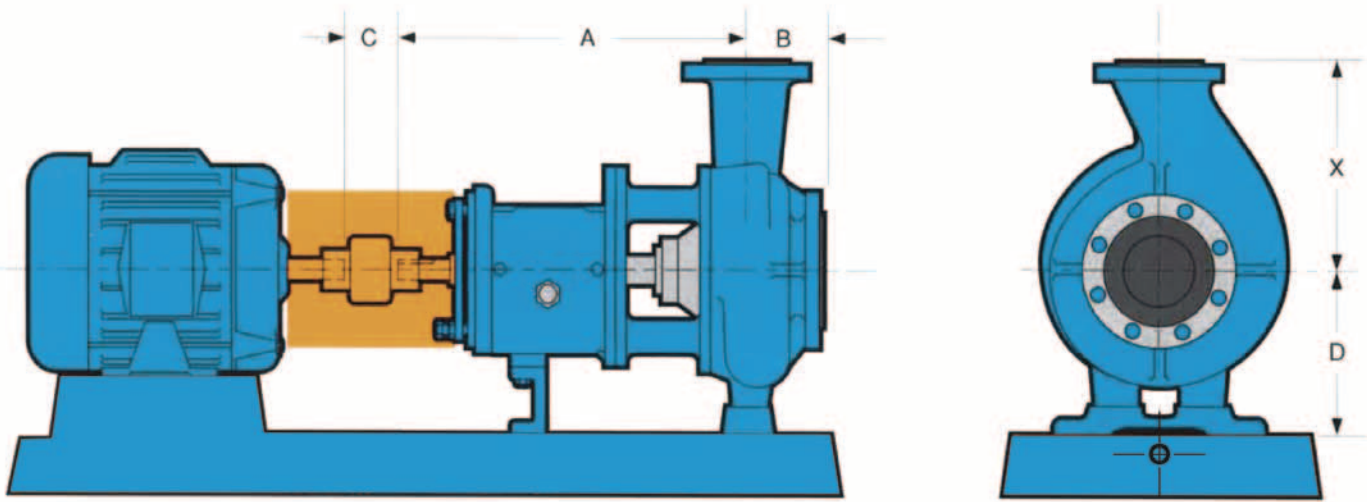

DIMENSIONS										
Group	Pump Size	ANSI Designation	Discharge Size	Suction Size	A	B	C	D	X	Bare Pump Weight Lbs. (kg)
3198 STi	1½x3-7	AB	1½	3	13½ (343)	4 (102)	3¾ (95)	5¼ (133)	6½ (165)	108 (49)
3198 MTi	1½x3-10	A50	1½	3	19½ (495)	4 (102)	3¾ (95)	8¼ (210)	8½ (216)	230 (104)
	3x4-10	A70	3	4					11 (279)	280 (127)
	3x4-13	A40	3	4				10 (254)	12½ (318)	343 (156)

Baseplate Mounting Options

Goolds offers a complete range of mounting systems to meet plant reliability requirements, and to make alignment and maintenance easier.

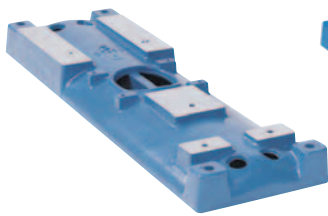

CAMBER TOP CAST IRON
Rigid and corrosion resistant, it is preferred by many plants.

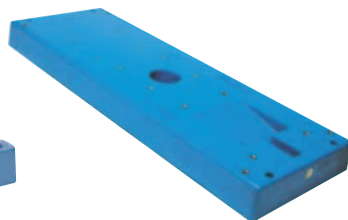

CHEMBASE PLUS™
Polymer concrete construction provides exceptional rigidity and corrosion resistance. ANSI 1991 dimensional.

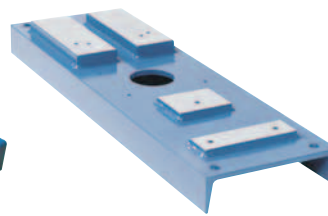

FABRICATED STEEL
Economical baseplate that meets ANSI/ASME B73.1 M current edition dimensional requirements.

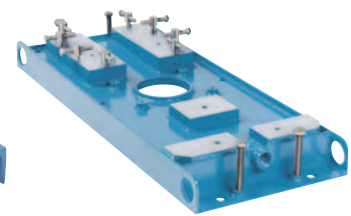

ENHANCED FEATURE FABRICATED STEEL
Upgraded ANSI baseplate designed to maximize pump operation life and ease installation by meeting API-minded chemical pump users toughest requirements.





PRO Services®
Extending
Equipment Life...

Product Repair (all types and brands of rotating equipment)

- Service Center Repair
- Field Service
- Parts Supply

Reliability Improvement

- Inventory Management
- Replacement/Exchange
- Turnkey Repair/Installation
- Training

Optimization of Assets

- Predictive Analysis/Condition Monitoring
 - Root Cause Failure Analysis
 - Pump & System Assessments
 - Upgrades – Mechanical & Hydraulic
 - Maintenance Management/Contract Maintenance
-
- Technical Expertise
 - Fast Turnaround
 - Factory Trained Service Personnel
 - Emergency Service – 24 hours/day, 7 days/week
 - Quality
 - ISO and Safety Certified

PROSMART

ProSmart® provides continuous machinery monitoring to identify little problems before they become big problems...like downtime.

Using wireless technology, advanced signal processing capabilities, and easy-to-deploy sensors, ProSmart offers an affordable means to monitor all of your rotating equipment anywhere in the world. By identifying and alerting you to changes in operating conditions, ProSmart increases your time to respond to either correcting the upset condition, or properly plan its repair.



Key Features include:

- Continuous data acquisition and analysis – ProSmart collects vibration, temperature, and available process conditions every five seconds; saving you time from routine data collection.
- Automatic Notification and Accessibility – By alerting when a machine goes into distress, you are able to focus your resources on recovery activities. The ProNet web-hosted solution allows access to information anywhere in the world through a standard Internet browser connection.
- Advanced diagnostic tools – More than simple overall data, ProSmart provides advanced analysis capabilities such as time-waveform, spectral, and spectral windowing.
- Easy to deploy – Using plug and play sensors, wireless connectivity, and an industrially hardened enclosure, ProSmart can be easily deployed throughout your plant, including hazardous areas.

PUMPSMART

PumpSmart® is the latest advancement in pump control and protection to reduce energy consumption, increase uptime and decrease maintenance cost. It allows the pump to be right-sized to the application by dialing in the speed and torque which increases flow economy, reduces heat and vibration, and improves overall system reliability.

- **Simplified Pump Control** – PumpSmart was designed specifically to optimize pumping applications and can be used to control a single pump or coordinate between multiple pumps without the need for an external controller.
- **Pump Protection** – PumpSmart guarantees to protect the pump from upset conditions with patented sensorless pump protection algorithms.
- **Smart Flow** – PumpSmart features a sensorless flow function for centrifugal pumps that can calculate the flow of the pump within ± 5% of the pump rated flow.
- **Drive for the DCS** – While most VFDs can only provide basic information, PumpSmart offers unparalleled insight to the pump operation which allows for smoother process control and efficiency.
- **Pump Experts** – PumpSmart is a variable speed drive with pump-specific algorithms imbedded into the drive. With over 150 years of pump knowledge, let the pump experts take responsibility of your pump system.



Visit our Web site at www.gouldspumps.com

