

Goulds 3181

High-temperature/Pressure Paper Stock/
Process Pumps

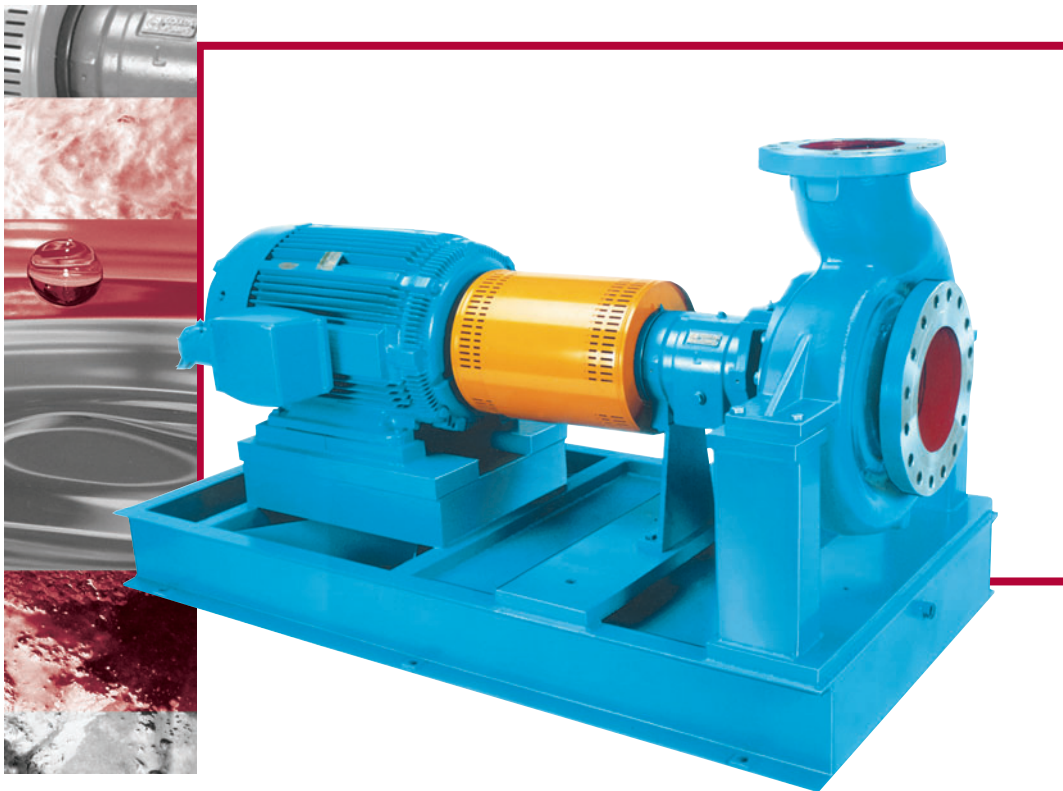

ITT

Engineered for life

Goulds 3181

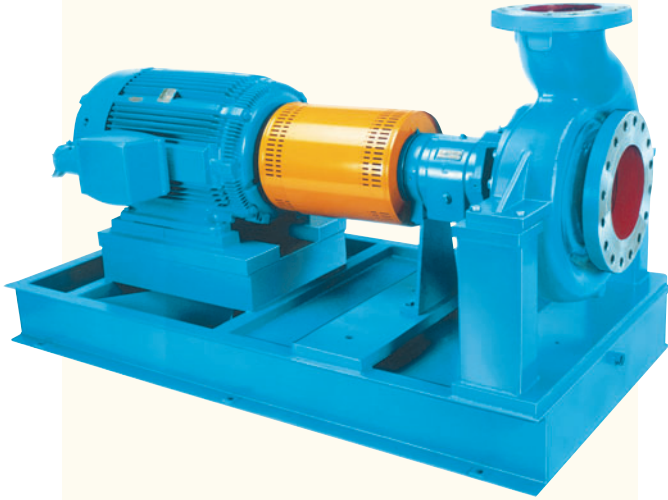

- ◆ ANSI Class 300 flange drilling
- ◆ Inch-dimensioned O.D. of mechanical seal sleeve
- ◆ Inch-dimensioned bearing locknut
- ◆ Inch-dimensioned coupling extension

Designed to Handle High Temperature and High Pressure Services of the Pulp & Paper Industries

- ◆ Capacities to 13,000 GPM (3000 m³/h)
- ◆ Heads to 410 feet (125 m)
- ◆ Temperatures to 508°F (300°C)
- ◆ Pressures to 360 PSIG (25 bar)

Design Features

- ◆ **Hydraulic Coverage** – Line designed for full 50/60 Hz performance.
- ◆ **Back Pull-out Construction** – Spacer type coupling allows one-craft maintenance.
- ◆ **Centerline Supported** – High temperature stability.
- ◆ **Labyrinth Seals** – Eliminate loss of lubricant, prevent lubricant contamination for maximum bearing life.
- ◆ **Maximum Interchangeability** – Power end and impellers completely interchangeable with Goulds Model 3180.
- ◆ **International Design** – Metric fasteners and fittings used throughout.

Services

Digester recirculation

Make-up liquor

White liquor

Black liquor

High pressure/high temperature pulp mill services

Hot oil



Model 3181

CASING

- ◆ End suction, top centerline discharge, self-venting.
- ◆ Centerline mounted for high temperature services.
- ◆ Back pull-out design.

ENCLOSED IMPELLER

High-efficiency design. Large balance holes and back pump-out vanes minimize stuffing box pressure and axial thrust. Standard with casing and impeller wear rings.

LABYRINTH SEALS

Inpro VBXXD labyrinth isolators prevent premature bearing failure caused by lubricant contamination and/or loss of lubricant.

TAPERBORE™ PLUS SEAL CHAMBER

Oversized tapered bore seal chamber improves circulation and cooling at seal faces, eliminates solids build-up in chamber for longer seal life. Standard with mechanical seal arrangement.

CONTINUOUS HIGH-PERFORMANCE

Original high-efficiency maintained by simple external impeller adjustment resulting in long-term energy savings.

DRY SHAFT

Teflon* O-rings in impeller nut and shaft sleeve assure positive sealing of shaft from pumpage.

CONFINED SPIRAL-WOUND GASKET

Spiral-wound stainless steel, provides metal-to-metal fit between casing and cover.

CASING AND IMPELLER WEAR RINGS

Renewable wear rings minimize maintenance costs. Fastened by set screws.

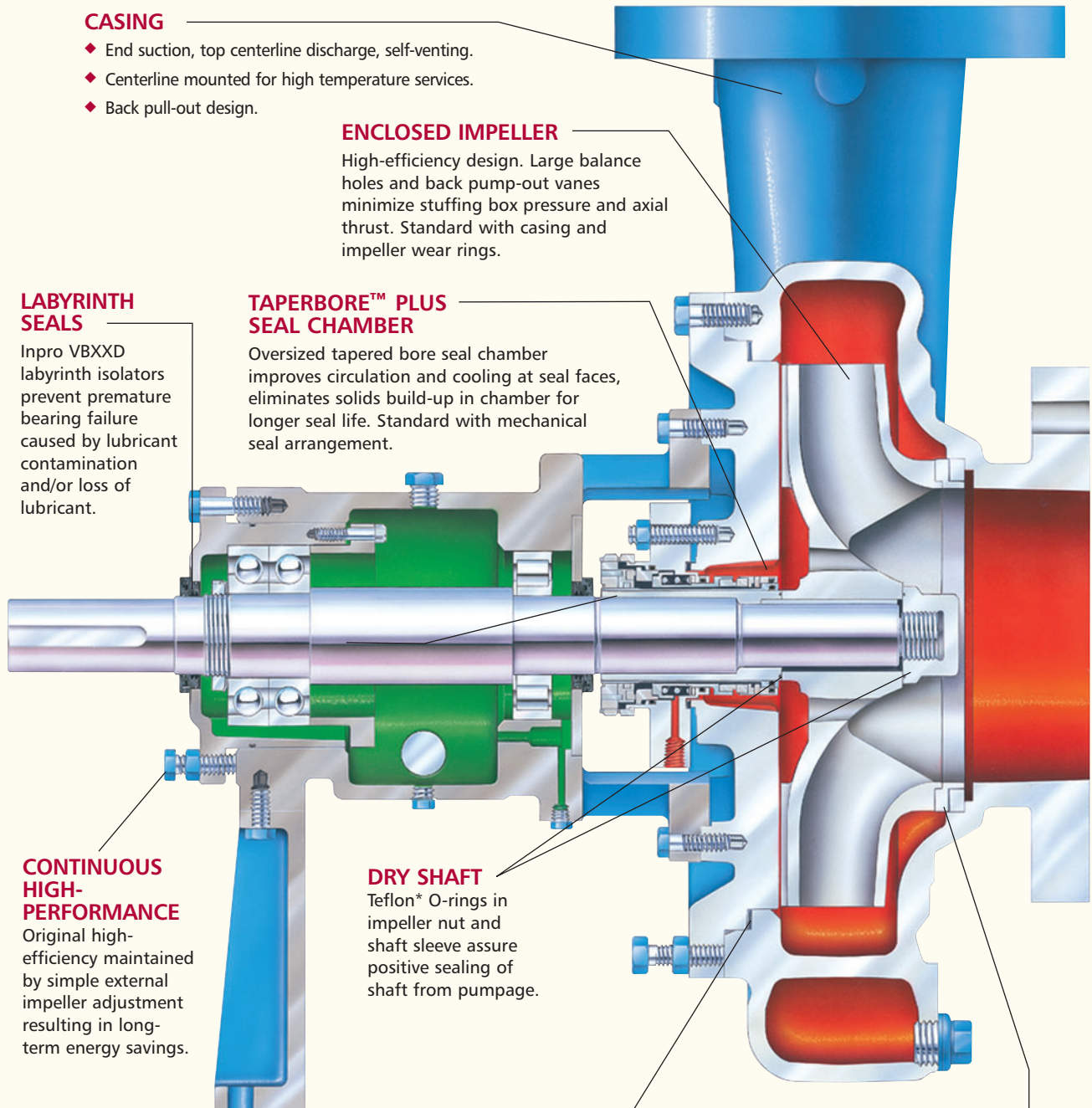

* E.I. DuPont Reg. Trademark

Performance Features for Extended Pump Life

LABYRINTH SEALS

Inpro VBXXD labyrinth isolators are standard. Prevent premature bearing failure caused by lubricant contamination or loss of oil.

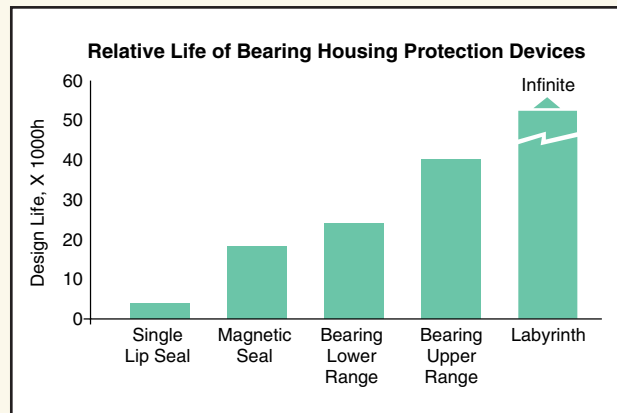
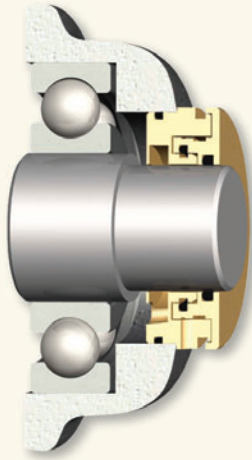

TAPERBORE™ SEAL CHAMBER

Enlarged, tapered bore for increased life of mechanical seals through improved lubrication and cooling. Self-venting and draining. VPE ring is optional.

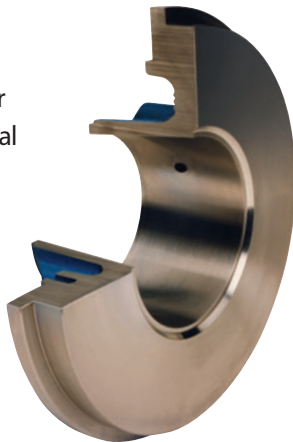

CENTERLINE SUPPORTED

For high temperature services. Eliminates misalignment of pump and motor shafts due to thermal expansion of casing.

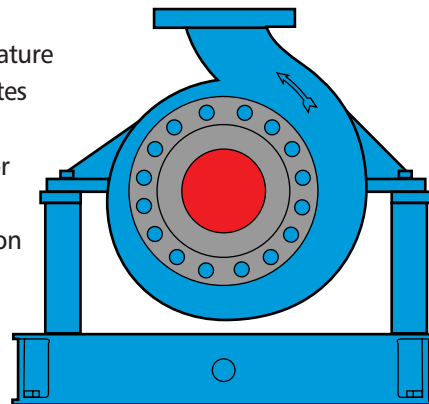

HEAVY DUTY SHAFT/BEARINGS

Shaft designed for minimum deflection for long seal life and bearing life. Bearings sized for optimum life under tough conditions.



ENCLOSED IMPELLER

High efficiency design. Large balance holes and back pump-out vanes reduce axial thrust and stuffing box pressure.

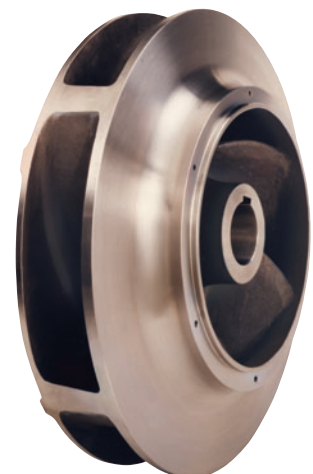

Features for Ease of Maintenance

1. BACK PULL-OUT

Allows unit to be removed without disturbing suction and discharge piping. Simple and fast installation of spare power end.

2. EXTERNAL IMPELLER ADJUSTMENT

Easy renewal of impeller clearances to maintain original hydraulic performance. Accomplished on-site with minimum downtime.

3. CONDITION MONITORING SITES

Allow easy and consistent monitoring of temperature and vibration for preventive maintenance.

4. MAXIMUM STUFFING BOX/SEAL CHAMBER ACCESSIBILITY

Allows easy maintenance of packing or mechanical seal.

MAXIMUM INTERCHANGEABILITY

The 3181 utilizes the same power ends as Goulds Model 3180 for reduced spare parts inventory requirements.



1.

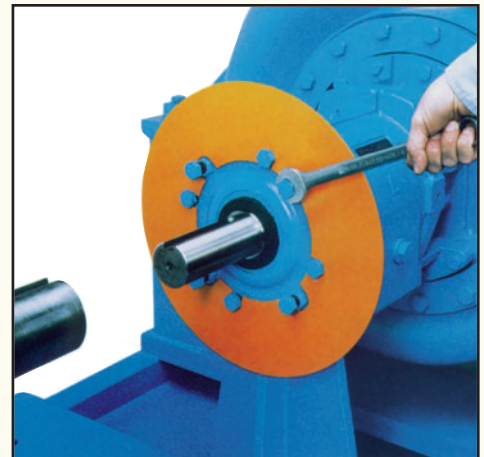

2.



3.



4.

Hydraulic Coverage Charts

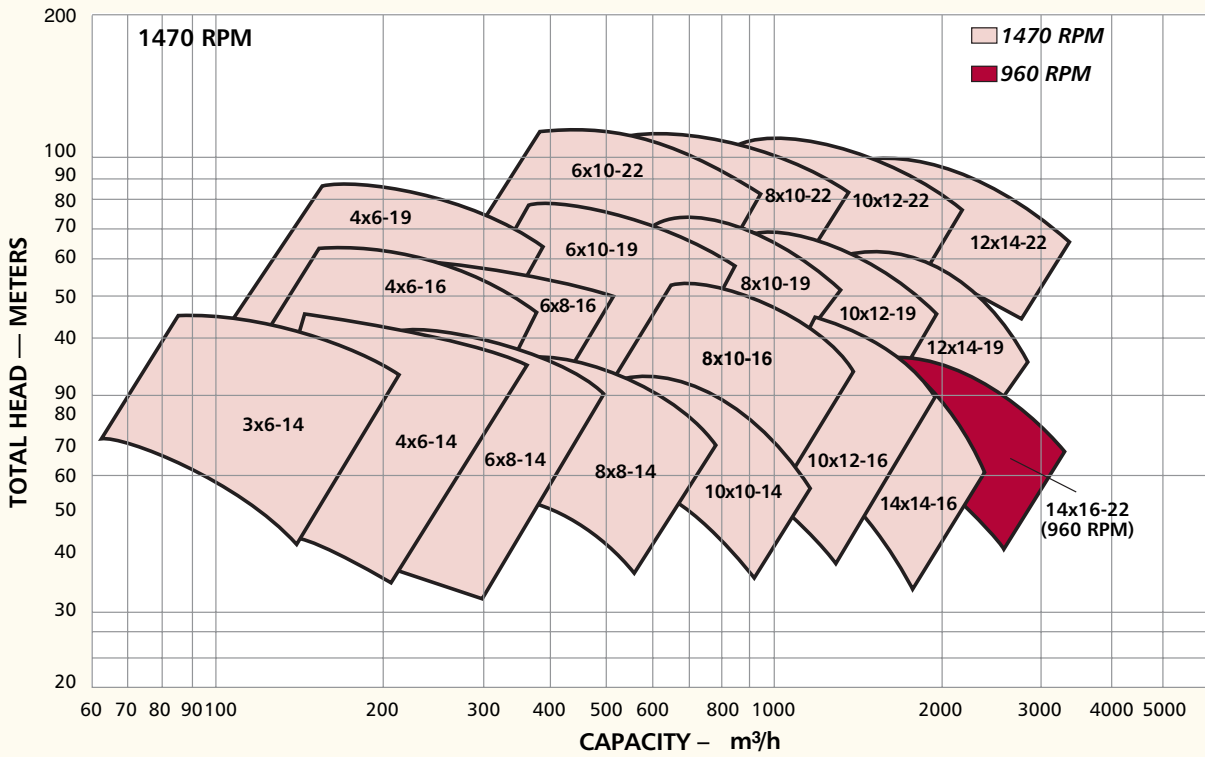
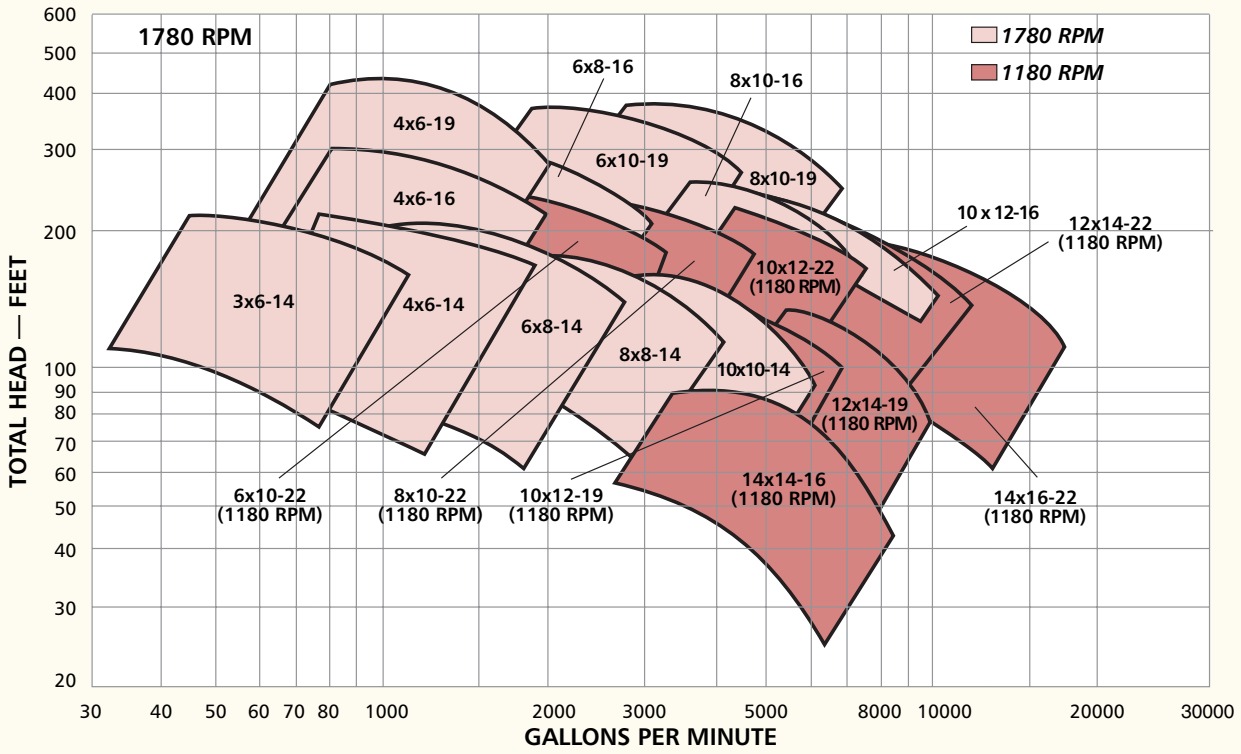



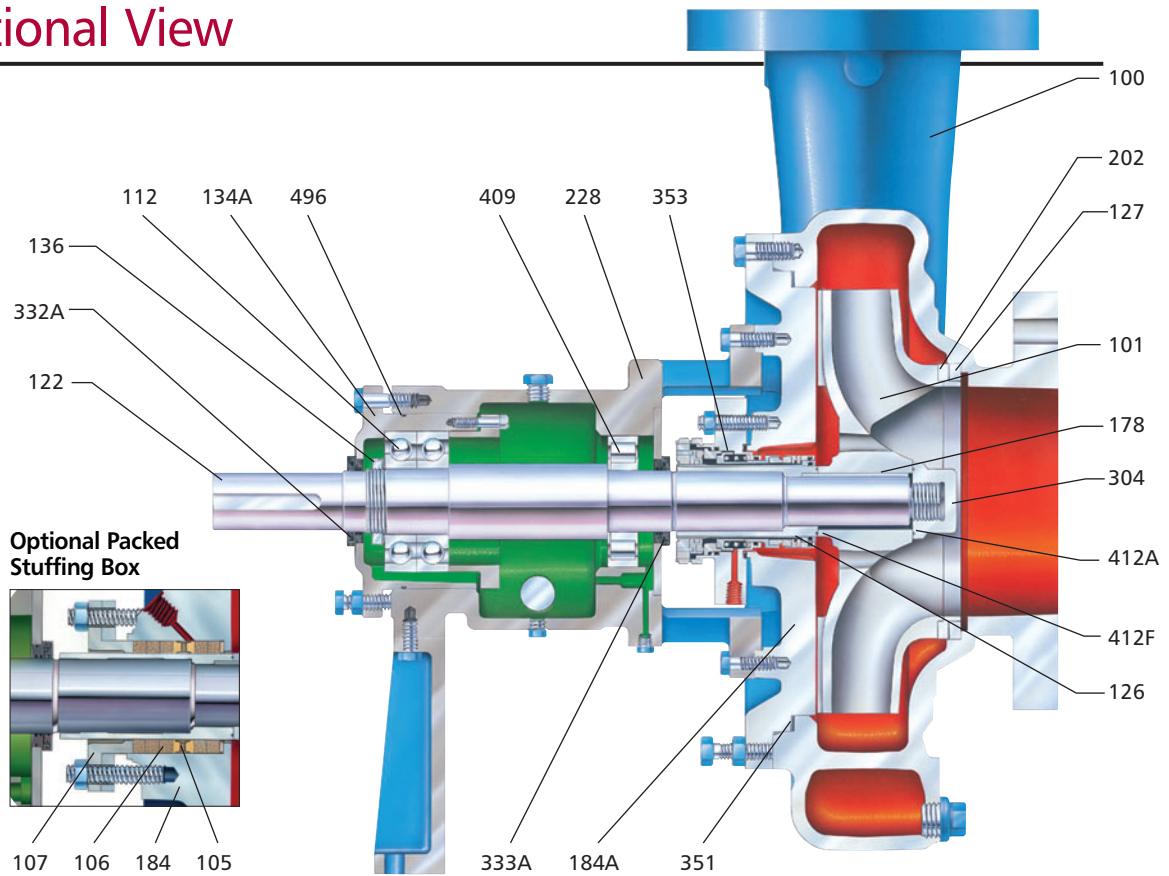







Sectional View

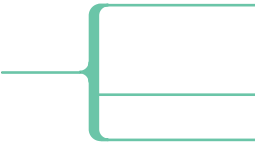
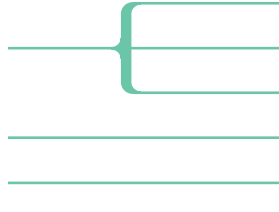

Parts List and Materials of Construction

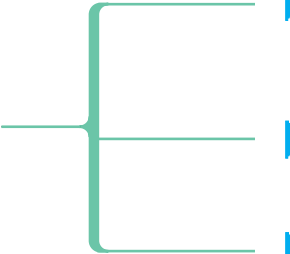
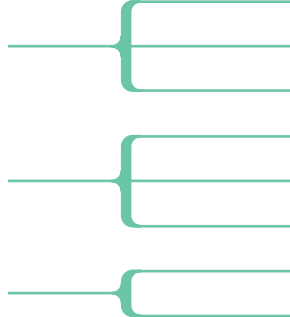
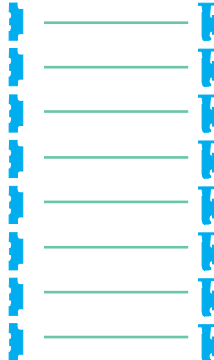
Item Number	Part Name	Material		
		Duplex (A890 GR3A)	316 Stainless Steel	317 Stainless Steel
100	Casing	Duplex	316 SS	317 SS
101	Impeller	Duplex	316 SS	317 SS
105	Lantern Ring		Teflon®	
106	Packing	Lattice Braid Garfite Yarn (Impregnated with Garfite 200)		
107	Gland	Duplex	316 SS	317 SS
112	Thrust Bearing	Duplex Angular Contact		
122	Shaft	Carbon Steel (4340)		
126	Shaft Sleeve		316 SS	317 SS
127	Casing Wear Ring	Duplex	316 SS	317 SS
134A	Bearing Housing		Cast Iron	
136	Bearing Locknut and Lockwasher		Steel	
178	Impeller Key		Carbon Steel	
184A	Taperbore™ Seal Chamber (Mechanical Seal)	Duplex	316 SS	317 SS
184	Stuffing Box Cover (Packed Box)	Duplex	316 SS	317 SS
202	Impeller Wear Ring	Duplex	316 SS	317 SS
228	Bearing Frame		Cast Iron	
304	Impeller Nut	Duplex	316 SS	317 SS
332A	Labyrinth Oil Seal (Outboard)		Bronze with Viton O-Rings	
333A	Labyrinth Oil Seal (Inboard)		Bronze with Viton O-Rings	
351	Casing Gasket		Spiral Wound Stainless Steel	
353	Mechanical Seal		(As Required)	
409	Radial Bearing		Cylindrical Roller	
412A	Impeller O-Ring		Teflon	
412F	Sleeve O-Ring		Teflon	
496	Bearing Housing O-Ring		Buna Rubber	

Modular Interchangeability

	Power End*	Stuffing Box/ Seal Chamber	Impeller and Wear Rings	Casing	Size
S Group					3x6-14
					4x6-14
					4x6-16
M Group					6x8-14
					8x8-14
					10x10-14
					6x8-16
					4x6-19
L Group					8x10-16
					10x12-16
					14x14-16
					6x10-19
					8x10-19
					10x12-19
					6x10-22
8x10-22					
XL Group					12x14-19
					10x12-22
					12x14-22
					14x16-22

* Shafts for Models 3181 and 3186 are not interchangeable.
Sleeves for mechanical seals on the 3181 and 3186 are not interchangeable.

Visit our website at www.gouldspumps.com

